



ADLINK
TECHNOLOGY INC.

MXE-200 Series

MXE-200/200i

Fanless Embedded Computer

User's Manual

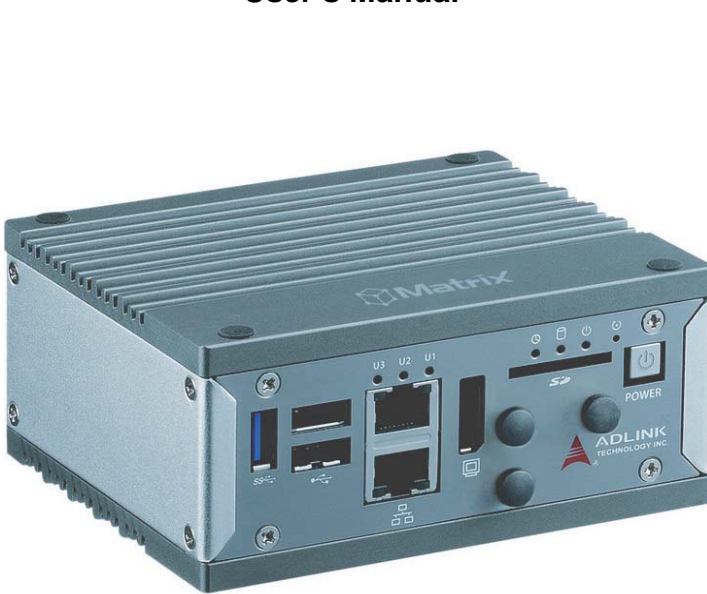

Manual Rev.: 2.00

Revision Date: Dec. 31, 2014

Part No: 50-1Z177-1000

Advance Technologies; Automate the World.

Revision History

Revision	Release Date	Description of Change(s)
2.00	Dec.31, 2014	Initial Release

Preface

Copyright 2014 ADLINK Technology, Inc.

This document contains proprietary information protected by copyright. All rights are reserved. No part of this manual may be reproduced by any mechanical, electronic, or other means in any form without prior written permission of the manufacturer.

Disclaimer

The information in this document is subject to change without prior notice in order to improve reliability, design, and function and does not represent a commitment on the part of the manufacturer.

In no event will the manufacturer be liable for direct, indirect, special, incidental, or consequential damages arising out of the use or inability to use the product or documentation, even if advised of the possibility of such damages.

Environmental Responsibility

ADLINK is committed to fulfill its social responsibility to global environmental preservation through compliance with the European Union's Restriction of Hazardous Substances (RoHS) directive and Waste Electrical and Electronic Equipment (WEEE) directive. Environmental protection is a top priority for ADLINK. We have enforced measures to ensure that our products, manufacturing processes, components, and raw materials have as little impact on the environment as possible. When products are at their end of life, our customers are encouraged to dispose of them in accordance with the product disposal and/or recovery programs prescribed by their nation or company.

Trademarks

Product names mentioned herein are used for identification purposes only and may be trademarks and/or registered trademarks of their respective companies.

Conventions

Take note of the following conventions used throughout this manual to make sure that users perform certain tasks and instructions properly.



NOTE:

Additional information, aids, and tips that help users perform tasks.



Information to prevent **minor** physical injury, component damage, data loss, and/or program corruption when trying to complete a task.



Information to prevent **serious** physical injury, component damage, data loss, and/or program corruption when trying to complete a specific task.

Table of Contents

Preface	iii
List of Tables	xi
List of Figures	xiii
1 Introduction	1
1.1 Overview	1
1.2 Features	2
1.3 Specifications	3
1.4 Unpacking Checklist	5
1.5 Mechanical Drawings	6
1.6 Front Panel I/O Connectors	8
1.6.1 Power Button	8
1.6.2 LED Indicators	9
1.6.3 Reset Button	9
1.6.4 HDMI Connector	10
1.6.5 Dual Gigabit Ethernet Ports	11
1.6.6 USB 3.0 Port	12
1.7 (Right) Side Panel I/O Connectors	12
1.7.1 DB-9P COM Port Connector	13
1.8 Internal I/O Connectors	14
1.8.1 mSATA/mini PCIe Selection Jumpers	16
1.8.2 DC 5V and 3.3V Connectors for GPS Module	16
1.8.3 USIM Port	17
1.8.4 Extendable Power/Reset/LED	17
2 Getting Started	19
2.1 Installing a Mini-PCIe Device	19
2.2 Connecting DC power	26
2.3 DIN-RAIL mounting of the MXE-200	27

2.4	Cooling Considerations.....	28
3	Driver Installation.....	29
3.1	Installing the Chipset Driver.....	29
3.2	Installing the Graphics Driver.....	30
3.3	Installing the Ethernet Driver.....	30
3.4	Installing the USB 3.0 Driver.....	31
3.5	Installing the I/O Driver	31
3.6	Installing the SEMA Utility, WDT and DI/O Drivers.....	31
A	Appendix: Watchdog Timer (WDT) & DI/O Function Libraries.....	33
A.1	WDT with API/Windows.....	33
	InitWDT	33
	SetWDT	34
A.2	DI/O with API/Windows.....	36
	GPIO_Init	36
	GPI_Read()	36
	GPO_Write()	37
	GPO_Read()	37
B	Appendix: BIOS Setup.....	39
B.1	Main.....	40
	B.1.1 BIOS Information	40
	B.1.2 System Time/System Date	40
	B.1.3 System Management.....	41
	Board Information	41
	Temperatures and Fan Speed	41
	Power Consumption	41
	Runtime Statistics	42
	Flags	42
	Power Up	42
B.2	Advanced.....	43

B.2.1	CPU Configuration.....	44
	Limit CPUID Maximum	44
	Execute Disable Bit	44
	Intel Virtualization Technology	44
	Power Technology	44
B.2.2	SATA Configuration.....	48
	Serial-ATA (SATA)	48
	SATA Speed Support	48
	SATA Mode	48
	Serial-ATA Port 0	48
	SATA Port0 HotPlug	49
B.2.3	USB Configuration.....	49
	Legacy USB Support	49
	XHCI Hand-Off	49
	EHCI Hand-Off	50
	USB Mass Storage Driver Support	50
	USB transfer time-out	50
	Device reset time-out	50
	Device power-up delay	50
B.2.4	SDIO Configuration	52
	SDIO Access Mode	52
B.2.5	Network Configuration.....	53
	Network Stack	53
B.2.6	Baytrail Feature Configuration.....	54
	LPSS & SCC Devices Mode	54
	SCC SD Card Support	54
	DDR50 Support for SD Card	54
	MIPI HSI Support	54
	LPSS HSUART # Support	54
	HSUART Port Mode	55
B.2.7	ACPI Setting.....	55
	Enable ACPI Auto Configuration	55

	Enable Hibernation	55
	ACPI Sleep State	55
	Lock Legacy Resources	56
B.2.8	Thermal Configuration	56
	Critical Trip Point	56
	Passive Trip Point	56
	Active Cooling Trip Point	56
B.2.9	Security Configuration	57
	TXE	57
	TXE HMRFB0	57
	TXE Firmware Update	57
	TXE EOP Message	57
	TXE Unconfiguration Perform	57
B.2.10	Miscellaneous Configuration.....	58
	OS Selection	58
B.3	Security.....	59
	Administrator Password	59
	User Password	59
B.4	Boot	60
	Setup Prompt Timeout	60
	Bootup Num-Lock State	60
	Quiet Boot	60
	Fast Boot	60
	Boot Option Priorities	61
B.5	Exit.....	63
	Save Changes and Exit	63
	Discard Changes and Exit	63
	Save Changes and Reset	63
	Discard Changes and Reset	63
	Save Changes	63
	Discard Changes	64
	Restore Defaults	64

Save as User Defaults	64
Restore User Defaults	64
Launch EFI Shell from filesystem device	64
Reset System with ME disable ModeMEUD000	64
Important Safety Instructions	65
Getting Service.....	67

This page intentionally left blank.

List of Tables

Table 1-1:	MXE-200 Front Panel I/O Connector Legend.....	8
Table 1-2:	LED Indicators	9
Table 1-3:	HDMI Pin Assignment	10
Table 1-4:	Gigabit Ethernet Port LED Function	11
Table 1-5:	MXE-200 Rear Panel I/O Connector Legend	12
Table 1-6:	DB-9P COM Port Pin Assignment	13
Table 1-7:	MXE-200 Internal I/O Legend.....	15
Table 1-8:	Mini-PCIe Slot2 Connector Jumper Settings	16
Table 1-9:	DC 5V and 3.3V Connectors Pin Assignments	17
Table 1-10:	Extendable Power/Reset Connectors Pin Assignments.....	18

This page intentionally left blank.

List of Figures

Figure 1-1:	MXE-200 Functional Block Diagram.....	5
Figure 1-2:	Top View.....	6
Figure 1-3:	Front View	7
Figure 1-4:	(Right) Side View	7
Figure 1-5:	Front Panel I/O	8
Figure 1-6:	(Right) Side Panel I/O.....	12
Figure 1-7:	DB-9P COM Port	13
Figure 1-8:	Mainboard Top View.....	14
Figure 1-9:	Mainboard Underside View	15
Figure 1-10:	DC 5V and 3.3V Connectors Configuration.....	16
Figure 1-11:	Extendable Power/Reset Configuration.....	17

This page intentionally left blank.

1 Introduction



1.1 Overview

ADLINK's new Matrix MXE-200/200i ultra-compact embedded platform, based on the Intel® Atom™ SoC processor E3845/E3826, delivers the most reliable I/O design for maximum connectivity, and a full aluminum alloy enclosure with industry-class construction makes it the embedded system of choice for industrial automation and applications demanding reliability in harsh environments. Combined with ADLINK's embedded SEMA Cloud solution, the MXE-200/200i delivers manageability and robustness required by mission critical operations. In addition, MXE-200i fully supports Intel® Gateway Solutions for the Internet of Things (IoT), integrated Wind River® Intelligent Device Platform XT, and McAfee Embedded Control, all together guaranteeing cornerstone manageability and security critical to IoT-ready platforms.

With its two GbE LAN, two COM, two USB 2.0 and one USB 3.0 host ports, optional four isolated DI and four isolated DO w/ interrupt support, dual mini PCIe slots with one mSATA support and USIM socket support communication with connections such as WiFi, BT, 3G, and LTE, the MXE-200/200i enables seamless interconnection, ensuring interoperability between systems. Matrix's proven rugged construction assures operation in harsh environments with operating shock tolerance up to 100 G and an extended optional operating temperature range of -20°C to 70°C.

Implementing ADLINK's proprietary SEMA Cloud tool, the MXE-200/200i maximizes manageability and security for a world of applications, delivering efficient remote monitoring of system activity and health in real time, system control over a robust secured channel, and complete, fully manageable utilization of system resources. All told, the MXE-200/200i presents an intelligent, robust embedded system supporting wide application development and easy service deployment, presenting outstanding performance in Intelligent Transportation, Facility Management, Industrial Automation and Internet of Things (IoT).

1.2 Features

- ▶ Intel® Atom™ SoC processor E3845/E3826
- ▶ Extremely compact: 120 (W) x 100 (D) x 55 (H) mm
- ▶ Rich I/O:
 - ▷ 1x HDMI, 2x USB 2.0 + 1x USB 3.0, 2x GbE ports, optional 4 isolated DI/O
 - ▷ 2x mPCIe slots (one supporting mSATA), 1x USIM socket, 1x SDIO
- ▶ Optional DIN-rail/wall mounting
- ▶ Included ADLINK SEMA Cloud solution
- ▶ Full support for Intel® Gateway Solutions for the Internet of Things (IoT)

1.3 Specifications

	MXE-201	MXE-202
System Core		
Processor	Intel® Atom™ E3845	Intel® Atom™ E3826
Chipset	SoC with processor	
Video	1x HDMI	
Memory	2 GB DDR3L 1066 MHz memory down	
I/O Interface		
Ethernet	2 GbE ports (2x Intel® I210IT)	
Serial Ports	1x RS-232 (COM1) 1x BIOS-programmable RS-232/422/485 (Serial)	
USB	1 USB 3.0 ports + 2 USB 2.0 port	
DIO	4 optional DIO w/ 1.5KV isolation	
Mini PCIe	2 internal PCIe mini card sockets w/ 1 mSATA support	
USIM	1 USIM socket for 3G communication (used for a 3G-mini module)	
WDT	Supports watchdog timer	
Power Supply		
DC Input	Built-in 6-36 VDC wide-range DC input 3P pluggable connectors with latch (GND, V-, V+)	
AC Input	Optional 40 W external AC-DC adapter for AC input	
Storage		
SD	1 SD slot (SD/SDHC up to 16G)	
mSATA	1 mSATA shares slot with mini PCIe	
Physical		
Dimensions	120 (W) x 100 (D) x 55 (H) mm (4.68" x 3.9" x 2.17")	
Weight	650 g (1.43 lbs)	
Mounting	DIN-RAIL / Wall-mount kit	
Environmental		
Operating Temperature	Standard: 0°C to 50°C (w/HDD)	

	MXE-201	MXE-202
Extended Temperature	-20°C to 60°C (w/ industrial mSATA)	-20°C to 70°C (w/ industrial mSATA)
Storage Temperature	-40°C to 85°C (excl. HDD/SDD/CFAST)	
Humidity	~95% @ 40°C (non-condensing)	
Vibration	Operating, 5 Grms, 5-500 Hz, 3 axes (w/ mSATA)	
ESD	Contact +/-4 KV and Air +/-8 KV	
Shock	Operating, 50 G, half sine 11 ms duration (w/ mSATA)	
EMC	CE and FCC Class A	
Safety	UL, CB	



NOTE:

Cold boot of the system at -20°C and operation with 100% loading at 60°C is provided when the industrial solid-state drive storage option is implemented.

Power Consumption		
Power off	0.3W	In shutdown mode with DC input and only USB keyboard/mouse
System Idle	6.3W	Under Windows Desktop with no application programs executed
Processor full load	12.5W	Under Windows with 100% CPU utilization and 2D/3D graphics load
System full load	22W	Under Windows with 100% CPU utilization and simultaneous access to all I/O devices
Recommended power supply	40W	With consideration of voltage de-rating under high environmental temperature

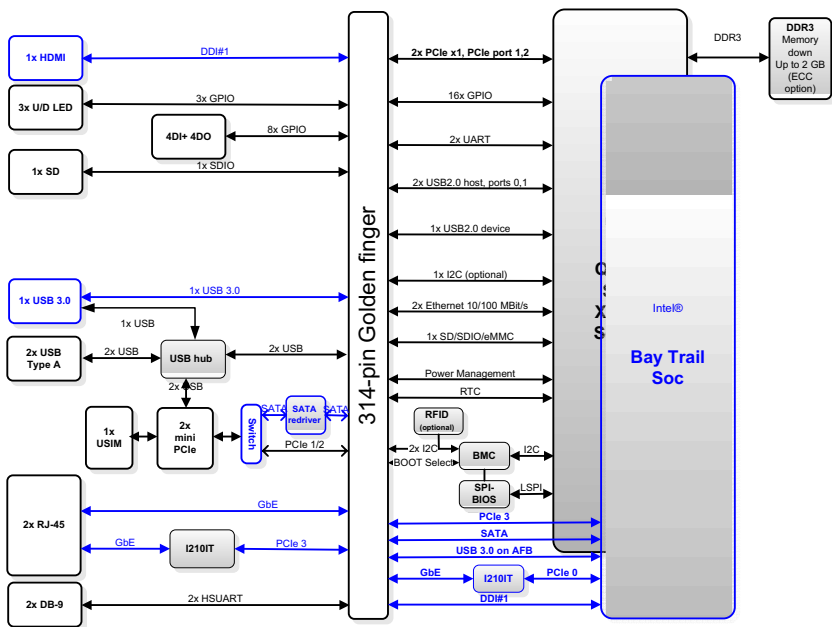

Figure 1-1: MXE-200 Functional Block Diagram

1.4 Unpacking Checklist

Before unpacking, check the shipping carton for any damage. If the shipping carton and/or contents are damaged, inform your dealer immediately. Retain the shipping carton and packing materials for inspection. Obtain authorization from your dealer before returning any product to ADLINK. Ensure that the following items are included in the package.

- ▶ MXE-200 unit
- ▶ DIN-RAIL/wall-mounting brackets
- ▶ Screw pack for DIN-RAIL/wall-mounting and storage fixing
- ▶ Quick Start Guide
- ▶ ADLINK All-in-One DVD

1.5 Mechanical Drawings



NOTE:

All dimensions shown are in millimeters (mm) unless otherwise stated.

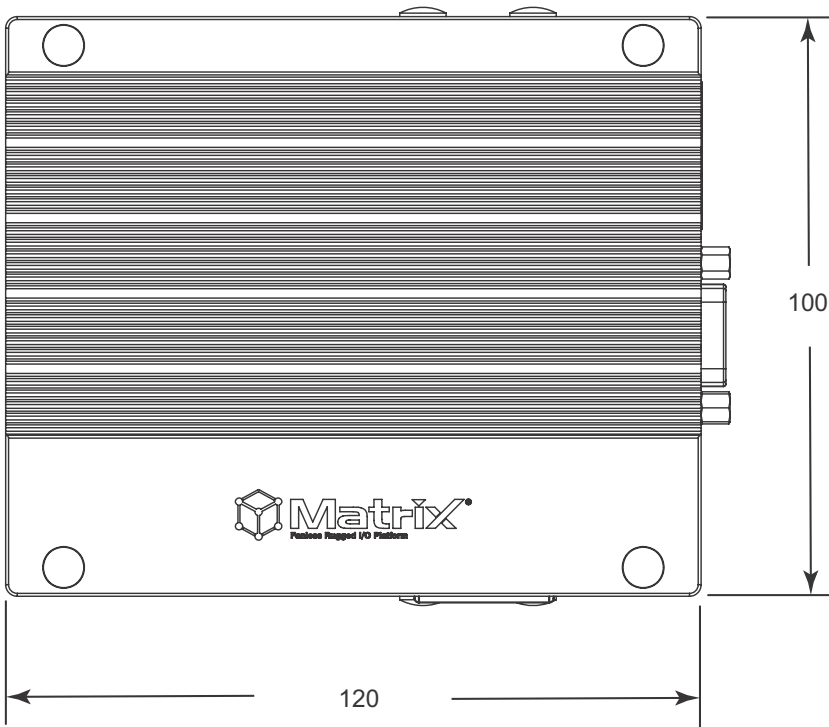

Figure 1-2: Top View

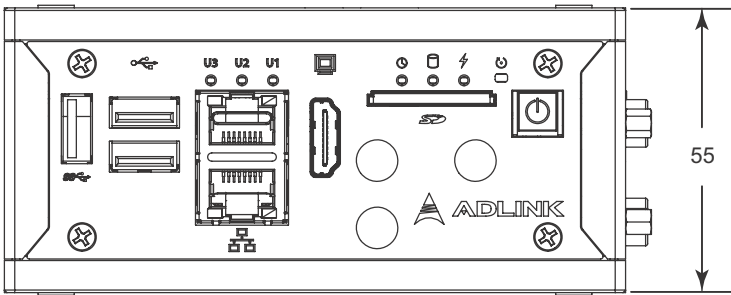

Figure 1-3: Front View

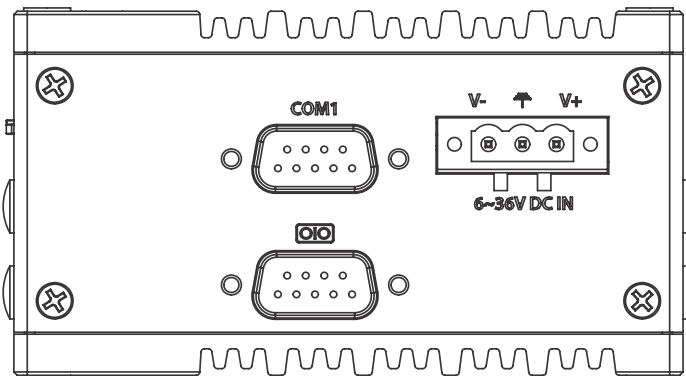

Figure 1-4: (Right) Side View

1.6 Front Panel I/O Connectors

This section describes the I/O connectors located on the front panel of the MXE-200.

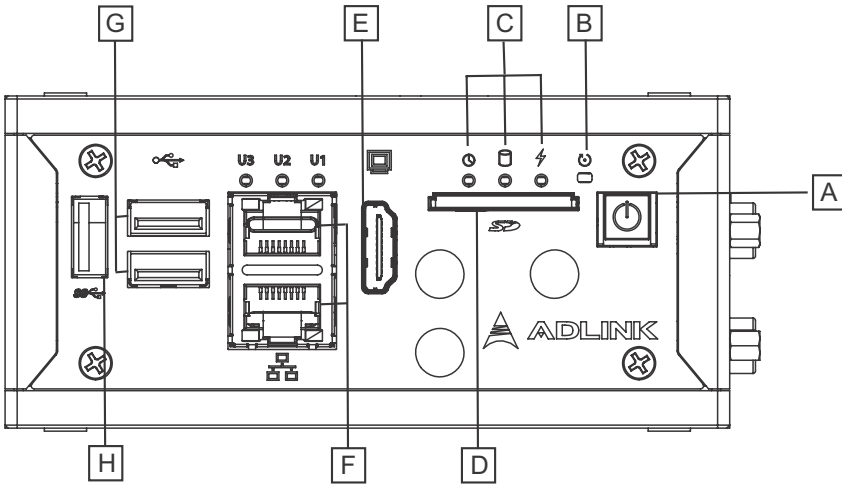

Figure 1-5: Front Panel I/O

A	Power Button	E	HDMI
B	Reset Button	F	GbE Port x2
C	LED Indicators	G	USB 2.0 Port x2
D	SD Card	H	USB 3.0 (Push-Push, Type II)

Table 1-1: MXE-200 Front Panel I/O Connector Legend

1.6.1 Power Button

The power button is a non-latched push button with a blue LED indicator. System is turned on when button is pressed, and the

power LED lit. If the system hangs, depressing the button for 5 seconds powers down the system.

1.6.2 LED Indicators

In addition to the LED of the power button, three LEDs on the front panel indicate the following operations.

Indicator	Color	Description
Watchdog (WDT)	Yellow	Indicates watchdog timer status. Flashes when watchdog timer starts, and when timer is expired, system will auto-reboots.
Hard disk drive	Orange	When blinking, indicates the SATA hard driver is active
Standby	Blue	Indicates the system is in power standby mode

Table 1-2: LED Indicators

1.6.3 Reset Button

The reset button executes hard reset for the MXE-200.

1.6.4 HDMI Connector

Provides connection to HDMI monitor or VGA, DVI monitor via HDMI-to-VGA adapter cable, and HDMI-to-DVI adapter cable.

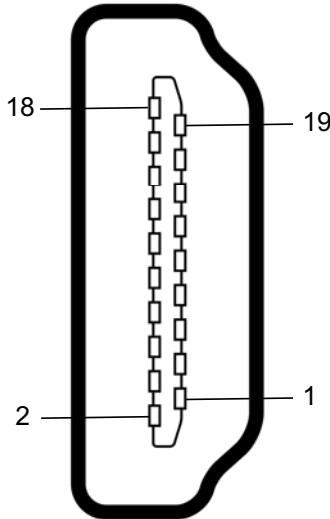

PIN	Signal	PIN	Signal
1	TMDS_DATA2+	11	TMDS_CLOCK_SHIELD
2	TMDS_DATA2_SHIELD	12	TMDS_CLOCK-
3	TMDS_DATA2-	13	CEC
4	TMDS_DATA1+	14	RESERVED
5	TMDS_DATA1_SHIELD	15	SCL
6	TMDS_DATA1-	16	SDA
7	TMDS_DATA0+	17	DDC/CEC GROUND
8	TMDS_DATA0_SHIELD	18	+5V POWER
9	TMDS_DATA0-	19	HOT PLUG DETECT
10	TMDS_CLOCK+		

Table 1-3: HDMI Pin Assignment

1.6.5 Dual Gigabit Ethernet Ports

The two Gigabit Ethernet ports on the front panel are based on an Intel WGI210IT GbE controller.

The WG210IT supports:

- ▶ IEEE 802.3az Energy Efficient Ethernet
- ▶ IEEE 1588/802.1AS precision time synchronization
- ▶ IEEE 802.3av traffic shaper
- ▶ Interrupt moderation, VLAN support, IP checksum offload
- ▶ PCIe OBFF (Optimized Buffer Flush/Fill) for improved system power management
- ▶ Four transmit and four receive queues
- ▶ RSS and MSI-X to lower CPU utilization in multi-core systems
- ▶ ECC - error correcting memory in packet buffers
- ▶ Wake-On-LAN
- ▶ NC-SI for greater bandwidth passthrough
- ▶ SMBus low-speed serial bus to pass network traffic
- ▶ Preboot eXecution Environment (PXE) flash interface support
- ▶ Jumbo frame support
- ▶ LAN Teaming

LED	LED Color	Status	Description
Active/Link	Yellow	OFF	Ethernet port is disconnected
		ON	Ethernet port is connected with no activity
		Flashing	Ethernet port is connected and active
Speed	Green/ Orange	OFF	10 Mbps
		Green	100 Mbps
		Orange	1000 Mbps

Table 1-4: Gigabit Ethernet Port LED Function

1.6.6 USB 3.0 Port

The USB 3.0 port supports Type A connection, compatible with SuperSpeed, Hi-Speed, full-speed and low-speed USB devices, with support for multiple boot devices, including USB flash, USB external HDD, and USB CD-ROM drivers and boot priority and boot device configured in BIOS.



NOTE:

When using USB CD-ROM via USB 3.0 port to re-install or repair the OS, cold boot should be utilized

1.7 (Right) Side Panel I/O Connectors

This section describes I/O connectors located on the side panel of the MXE-200.

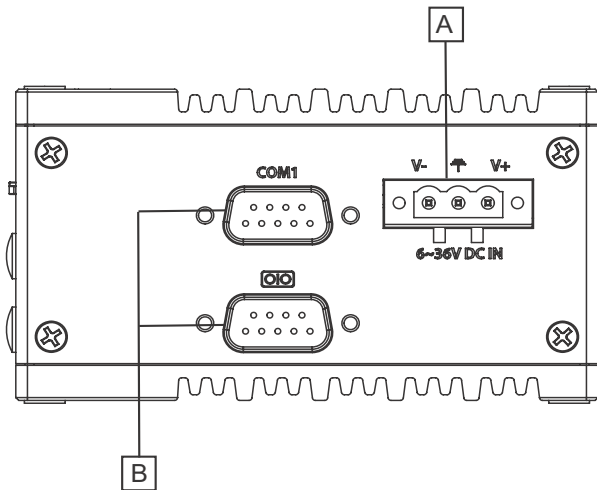

Figure 1-6: (Right) Side Panel I/O

A	DC power supply connector
B	DB-9P COM Ports

Table 1-5: MXE-200 Rear Panel I/O Connector Legend

1.7.1 DB-9P COM Port Connector

2 serial ports connect via DB-9P connectors.

COM1 supports RS-232, and the other selectively supports RS-232/ RS-422/ RS-485 mode by BIOS setting.

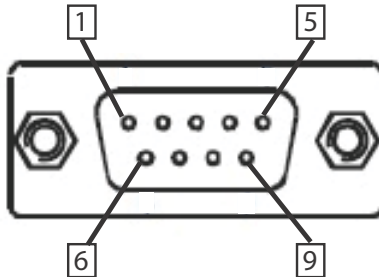

Figure 1-7: DB-9P COM Port

Pin	Signal		
	RS-232	RS-422	RS-485
1	N/C	TXD422-	485DATA-
2	RXD	TXD422+	485DATA+
3	TXD	RXD422+	N/C
4	N/C	RXD422-	N/C
5	GND	N/C	N/C
6	N/C	N/C	N/C
7	RTS#	N/C	N/C
8	CTS#	N/C	N/C
9	N/C	N/C	N/C

Table 1-6: DB-9P COM Port Pin Assignment

1.8 Internal I/O Connectors

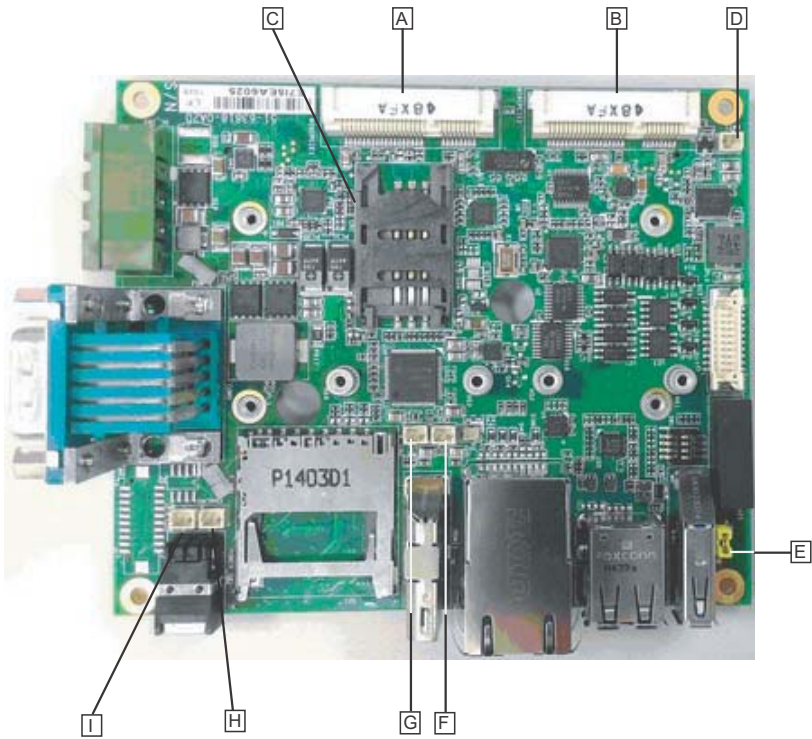

Figure 1-8: Mainboard Top View

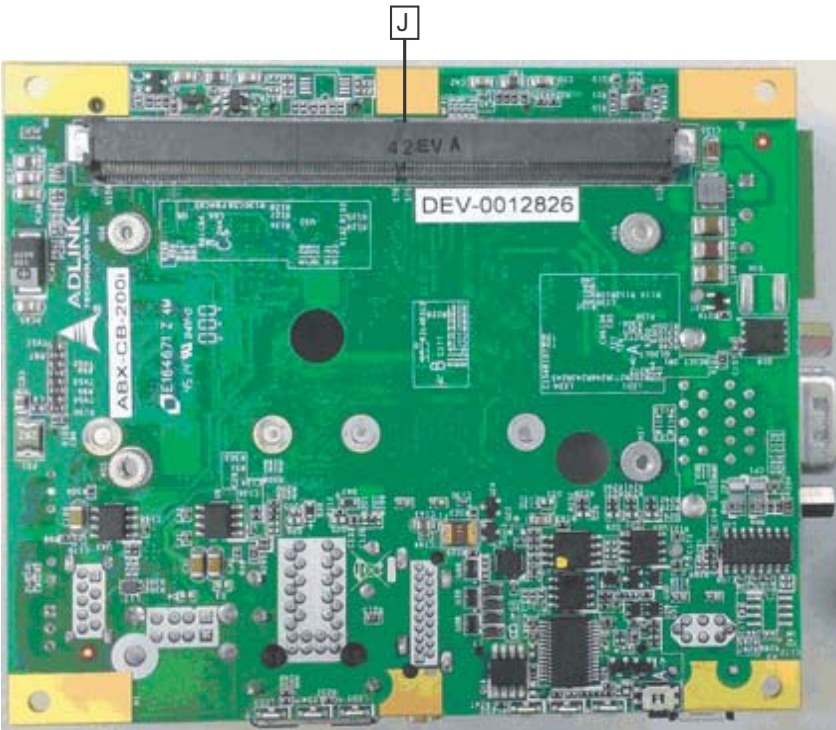

Figure 1-9: Mainboard Underside View

A	Mini-PCIe slot1	F	DC 3.3V connector for GPS module
B	Mini-PCIe slot2	G	DC 5V connector for GPS module
C	USIM slot	H	Extended reset wafer
D	RTC battery wafer	I	Extended power wafer
E	Switch mSATA / mini PCIe jumper for Mini-PCIe slot1	J	SMARC module slot

Table 1-7: MXE-200 Internal I/O Legend

1.8.1 mSATA/mini PCIe Selection Jumpers

One jumper is provided for Mini-PCIe slot2 to select mSATA or miniPCIe function.

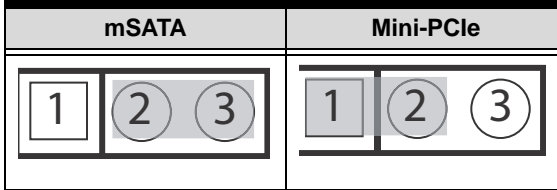

Table 1-8: Mini-PCIe Slot2 Connector Jumper Settings

1.8.2 DC 5V and 3.3V Connectors for GPS Module

The two power connectors, for GPS module use, carry a maximum current rating of 1A each.

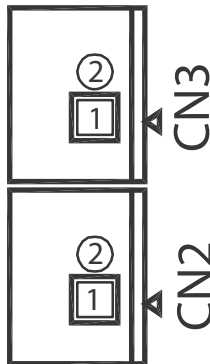

Figure 1-10: DC 5V and 3.3V Connectors Configuration

Pin	Description
CN19	
1	+5V
2	Gnd

Pin	Description
CN20	
1	+3.3V
2	Gnd

Table 1-9: DC 5V and 3.3V Connectors Pin Assignments

1.8.3 USIM Port

Use of 3.5G mini-PCIe module requires a SIM card for communication with a telecom operator. The MXE-200 provides a USIM port connected to the mini-PCIe connector, with which a SIM card and 3.5G mini-PCIe module can be installed to facilitate 3.5G communication.

1.8.4 Extendable Power/Reset/LED

The MXE-200i provides internal connectors for the Power button (from CN5) and Reset button (CN4) assigned as shown.

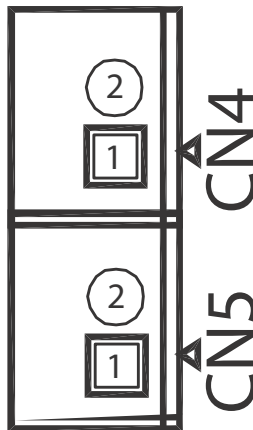

Figure 1-11: Extendable Power/Reset Configuration

Pin	Description
CN4	
1	Reset Button
2	GND
CN5	
1	Power Button
2	GND

Table 1-10: Extendable Power/Reset Connectors Pin Assignments

2 Getting Started

This chapter discusses installation of a mini-PCI-E module and mSATA. Wall-mount installation is also described.

2.1 Installing a Mini-PCIe Device

Before installing, remove the chassis underside as follows.

1. Remove the 8 screws as shown.



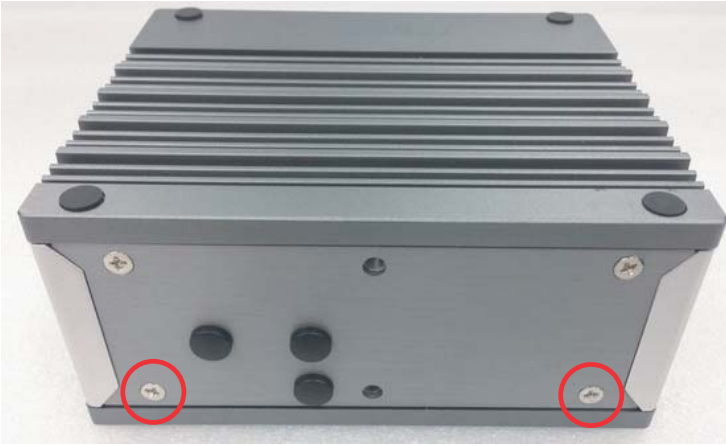

2. Remove the chassis underside.



3. Insert the mini-PCIE mSATA module into the slot at an angle



4. Depress the mini-PCI-E mSATA module until seated and fix with two 2 M2.5-P-head-L5 screws.

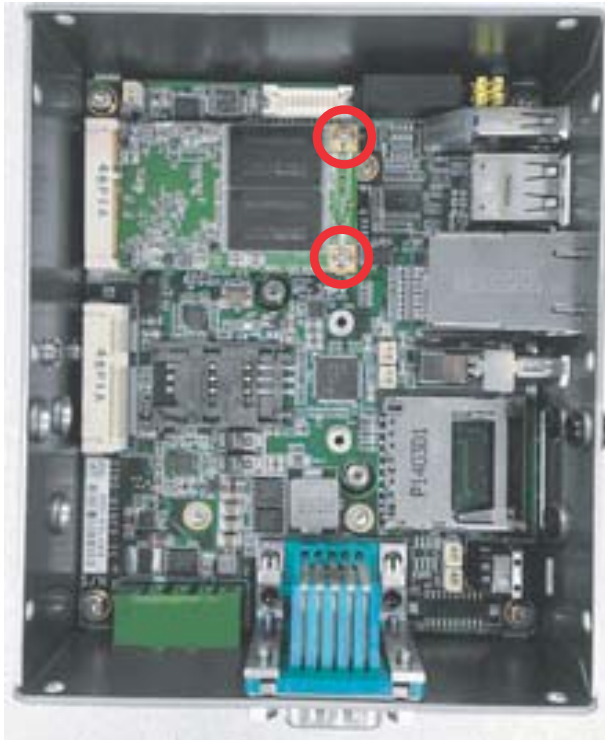

5. Insert the mini-PCIE wireless module into the slot at an angle.



6. Depress the mini-PCI-E wireless module until seated and fix with two 2 M2.5-P-head-L5 screws.



2.2 Connecting DC power



Before providing DC power to the MXE-200, ensure the voltage and polarity provided are compatible with the DC input. Improper input voltage and/or polarity can be responsible for system damage.

The DC power input connector of the MXE-200 utilizes V+, V-, and chassis ground pins, and accepts input voltage as shown previously.

1. Connect DC power cables as shown.
2. Fix the DC connector using the 2 screws.



2.3 DIN-RAIL mounting of the MXE-200

The MXE-200 controller is shipped with DIN-RAIL mounting brackets and accessory screws, with mounting procedures as follows.

1. Prepare the one DIN-RAIL mount brackets and 2 M4-F head screws included in the package.



2. Use the 2 included M4-F head screws to fix the DIN-RAIL mount brackets to the chassis, according to the spacing dimensions of the screw holes and brackets, as shown.

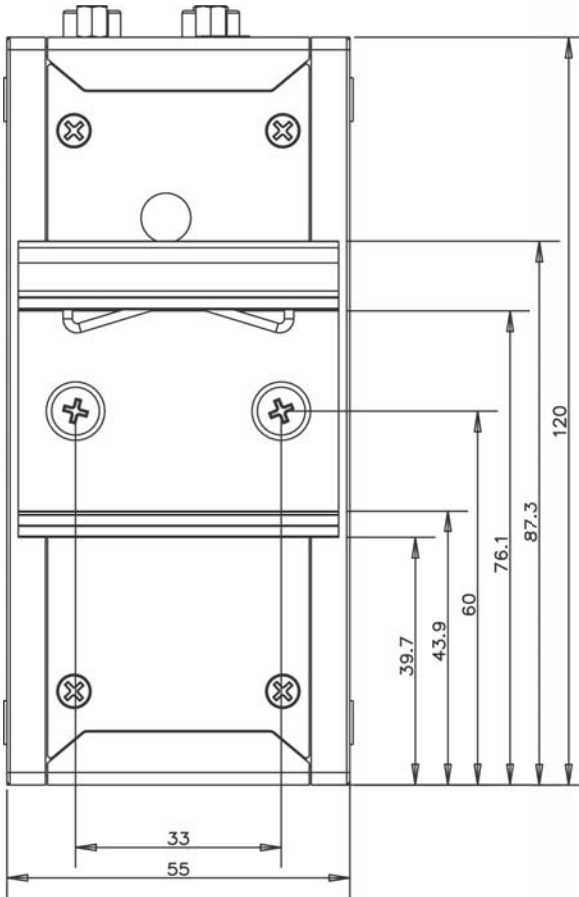

2.4 Cooling Considerations

Heat-generating components of the MXE-200 (such as CPU and PCH) are all situated on the left side of the system. These components directly contact the heat sink via thermal pads and dissipate heat generated by the components. To maximize efficiency of heat dissipation, maintain a minimum of 2 inches (5 cm) clearance on the top of the MXE-200.

3 Driver Installation

After installing the operating system, all related drivers must be installed for the system to function properly. This section describes the drivers needed for Windows operating systems and the procedures to install them. For other OS support, please contact ADLINK for further information.

Install drivers as follows.

1. Fully install Microsoft Windows OS before installing any drivers. Most standard I/O device drivers have been included in Microsoft Windows OS. For Windows 7 users, please note that you need Administrator privilege to install the drivers properly.
2. Install the chipset driver.
3. Install the graphics driver.
4. Install the Ethernet driver.
5. Install the USB 3.0 driver
6. Install the I/O driver.
7. Install the SEMA utility, WDT and DI/O drivers.

3.1 Installing the Chipset Driver

The chipset driver directs the operating system to configure the Intel® chipset components in order to ensure that the following features function properly:

- ▶ SATA Storage Support
- ▶ USB Support
- ▶ Identification of Intel® Chipset Components in the Device Manager

Microsoft Windows 7 must be fully installed and running on the system before installing this software:

To install the chipset driver for the MXE-200

1. Close any running applications.
2. Insert the ADLINK All-in-One DVD. The chipset driver is located in the directory
x:\Driver Installation\Matrix\MXE-200\Chipset
where x: denotes the DVD-ROM drive.
3. Execute Setup.exe and follow onscreen instructions to complete the setup.
4. After installation is complete, reboot the system.

3.2 Installing the Graphics Driver

The MXE-200 is equipped with the Intel® Graphics Media Accelerator Driver package, which supports Windows 7.

To install the graphics driver:

1. Close any running applications.
2. Insert the ADLINK All-in-One DVD. The graphics driver is located in the directory
x:\Driver Installation\Matrix\MXE-200\Graphics
where x: denotes the DVD-ROM drive.
3. Execute Setup.exe and follow onscreen instructions to complete the setup.
4. After installation is complete, reboot the system.

3.3 Installing the Ethernet Driver

To install the driver for the Intel 1210 Gigabit Ethernet controller:

1. Close any running applications.
2. Insert the ADLINK All-in-One DVD. The Ethernet driver is located in the directory
x:\Driver Installation\Matrix\MXE-200\LAN-Intel\
where x: denotes the DVD-ROM drive.
3. Execute autorun.exe and follow onscreen instructions to complete the setup.
4. After installation is complete, reboot the system.

3.4 Installing the USB 3.0 Driver

To install the driver for the USB 3.0 controller:

1. Close any running applications.
2. Insert the ADLINK All-in-One DVD. The Ethernet driver is located in:
x:\Driver Installation\Matrix\MXE-200\USB3.0\
where x: denotes the DVD-ROM drive.
3. Launch setup.exe and follow onscreen instructions to complete the setup.
4. After installation is complete, reboot the system.

3.5 Installing the I/O Driver

To install the driver for the I/O controller:

1. Close any running applications.
2. Insert the ADLINK All-in-One DVD. The Ethernet driver is located in:
x:\Driver Installation\Matrix\MXE-200\IO Drivers\
where x: denotes the DVD-ROM drive.
3. Execute setup.msi and follow onscreen instructions to complete the setup.
4. After installation is complete, reboot the system.

3.6 Installing the SEMA Utility, WDT and DI/O Drivers

The MXE-200 supports ADLINK Smart Embedded Management Utility with features as follows.

- ▶ System Health for real time CPU, system temperature, total/current uptime
- ▶ User-defined 1KB Flash
- ▶ Watchdog Timer
- ▶ Hardware Monitoring for input voltage levels and current power consumption

A WDT (watchdog timer) is a hardware mechanism resetting the system when the operating system or application is halted. A typi-

cal usage of WDT is to start the timers and periodically reset the timer, and when timer is expired, the system resets. SEMA utility installation is required to access the WDT function.

To install the SEMA utility, WDT and DI/O drivers:

1. Close any running applications.
2. Insert the ADLINK All-in-One DVD. The utility is located in the directory:

x:\Driver Installation\Matrix\MXE-200\WDT_SEMA_DIO\

where x: denotes the DVD-ROM drive.

3. Execute Setup.exe and follow onscreen instructions to complete the setup.

After installation is complete, reboot the system.



NOTE:

Administrator privilege is required to use the API in Windows 7.

Appendix A Watchdog Timer (WDT) & DI/O Function Libraries

This appendix describes use of the watchdog timer (WDT) function library for the MXE-200.

The watchdog timer is a hardware mechanism provided to reset the system if the operating system or an application stalls. After starting, the watchdog timer in the application must be periodically reset before the timer expires. Once the watchdog timer expires, a hardware-generated signal is sent to reset the system.

DI/O provides input/output to support inter-device communications. Simple programming guides allow easy transmission of digital signals between the system and attached peripherals.

A.1 WDT with API/Windows

Matrix WDT API library files and a demo program (incl. source code) can be found on the included driver CD or downloaded from <http://www.adlinktech.com>.

To use the WDT function library for MXE-200 series, include the header file `matrix_wdt.h` and linkage library `matrix_wdt.lib` in the C++ project.

InitWDT

Initializes watchdog timer function of MXE-200. `InitWDT` must be called before the invocation of any other WDT function.

@ Syntax

C/C++

```
BOOL InitWDT()
```

@ Parameters

None

@ Return code

TRUE if watchdog timer is successfully initialized.

FALSE if watchdog timer fails to initialize.

SetWDT

Sets the timeout value of the watchdog timer. There are two parameters for this function to indicate the timeout ticks and unit. ResetWDT or StopWDT should be called before the expiration of watchdog timer, or the system will reset.

@ Syntax

C/C++

```
BOOL SetWDT(BYTE tick, BYTE unit)
```

@ Parameters

tick

Specify the number of ticks for watchdog timer. A valid value is 1 - 255.

unit

Specify the timeout ticks of the watchdog timer.

Value	Description
0	The unit for one tick is one second. For example, when one tick is specified as 100 and the unit as 0, the timeout value is 100 seconds.
1	The unit for one tick is one minute. For example, when one tick is specified as 100 and the unit as 1, the timeout value is 100 minutes.

@ Return codes

TRUE if timeout value of watchdog timer is successfully set.

FALSE if timeout value of watchdog timer is failed to set.

StartWDT

Starts watchdog timer function. Once the StartWDT is invoked, the watchdog timer starts. ResetWDT or StopWDT should be called before the expiration of watchdog timer, or the system will reset.

@ Syntax

C/C++

```
BOOL StartWDT()
```

@ Parameters

None

@ Return codes

TRUE if watchdog timer is successfully started.

FALSE if watchdog timer is failed to start.

ResetWDT

Resets the watchdog timer. The invocation of `ResetWDT` allows restoration of the watchdog timer to the initial timeout value specified in `SetWDT` function. `ResetWDT` or `StopWDT` should be called before the expiration of the watchdog timer, or the system will reset.

@ Syntax

C/C++

```
BOOL ResetWDT()
```

@ Parameters

None

@ Return codes

TRUE if watchdog timer is successfully reset.

FALSE if watchdog timer fails to reset.

StopWDT

Stops the watchdog timer.

@ Syntax

C/C++

```
BOOL StopWDT()
```

@ Parameters

None

@ Return codes

TRUE if watchdog timer is successfully stopped.

FALSE if watchdog timer fails to stop.

A.2 DI/O with API/Windows

Matrix DI/O API library files and a demo program (incl. source code) are located on the included driver CD or downloaded from <http://www.adlinktech.com>.

To use the DI/O function library for MXE-200 series, include the header file `matrix_dio.h` and linkage library `matrix_dio.lib` in the C++ project.

DI/O functions are as follows.

GPIO_Init

Reserves system resources for digital input/output API service. It is necessary to call this function before using other MXE-200 DI/O functions.

@ Syntax

C/C++

```
I16 GPIO_Init(void)
```

@ Parameters

None

@ Return code

```
NoError  
ErrorOpenDriverFailed  
ErrorDeviceIoctl
```

GPI_Read()

Reads the digital logic state of the digital input line..

@ Syntax

C/C++

```
I16 GPI_Read(U16 *pwState)
```

@ Parameters

pwState

Returns the digital logic state of MXE-200 digital input channels 1 to 8 (bit 0 to 7)

@ Return code

```
NoError
ErrorOpenDriverFailed
ErrorDeviceIoctl
```

GPO_Write()

Sets the digital logic state of the digital output line.

@ Syntax

C/C++

```
I16 GPO_Write(U16 wState)
```

@ Parameters

State

Sets the digital logic state of MXE-200 digital output channels 1 to 8 (bit 0 to 7) to 0 or 1.

@ Return code

```
NoError
ErrorOpenDriverFailed
ErrorDeviceIoctl
```

GPO_Read()

Reads the digital logic state of the digital output line.

@ Syntax

C/C++

```
I16 GPO_Read(U16 *pwState)
```

@ Parameters

pwState

Returns the digital logic state of MXE-200 digital output channels 1 to 8 (bit 0 to 7).

@ Return code

NoError

ErrorOpenDriverFailed

ErrorDeviceIoctl

Appendix B BIOS Setup



NOTE:

BIOS options in the manual are for reference only, and are subject to configuration. Users are welcome to download the latest BIOS version from the ADLINK website.

The Basic Input/Output System (BIOS) is a program that provides a basic level of communication between the processor and peripherals. In addition, the BIOS also contains codes for various advanced features applied to the MXE-200. The BIOS setup program includes menus for configuring settings and enabling features of the MXE-200 series. Most users do not need to use the BIOS setup program, as the MXE-200 ships with default settings that work well for most configurations.



WARNING:

Changing BIOS settings may lead to incorrect controller behavior and possible inability to boot. In such a case, Section 1.8.1 on page 16 provides instruction on clearing the CMOS and restoring default settings

B.1 Main

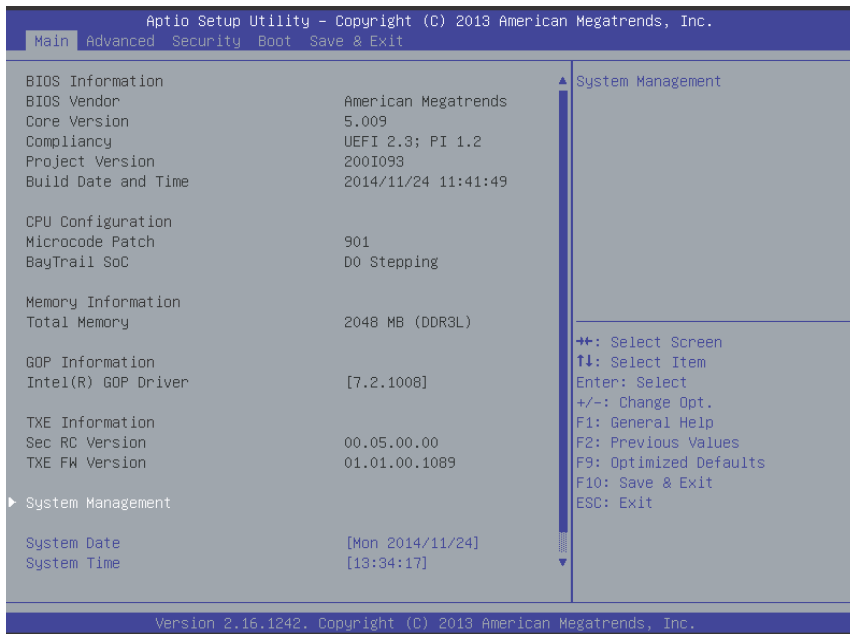

B.1.1 BIOS Information

Shows current system BIOS core version, BIOS version and Board version.

B.1.2 System Time/System Date

Changes system time and date. Highlight System Time or System Date using the up or down <Arrow> keys. Enter new values using the keyboard then <Enter>. Use < Tab > to move between fields. The date must be entered in MM/DD/YY format. The time is entered in HH:MM:SS format.



NOTE:

The time is in 24-hour format, for example, 5:30 A.M. appears as 05:30:00, and 5:30 P.M. as 17:30:00.

B.1.3 System Management

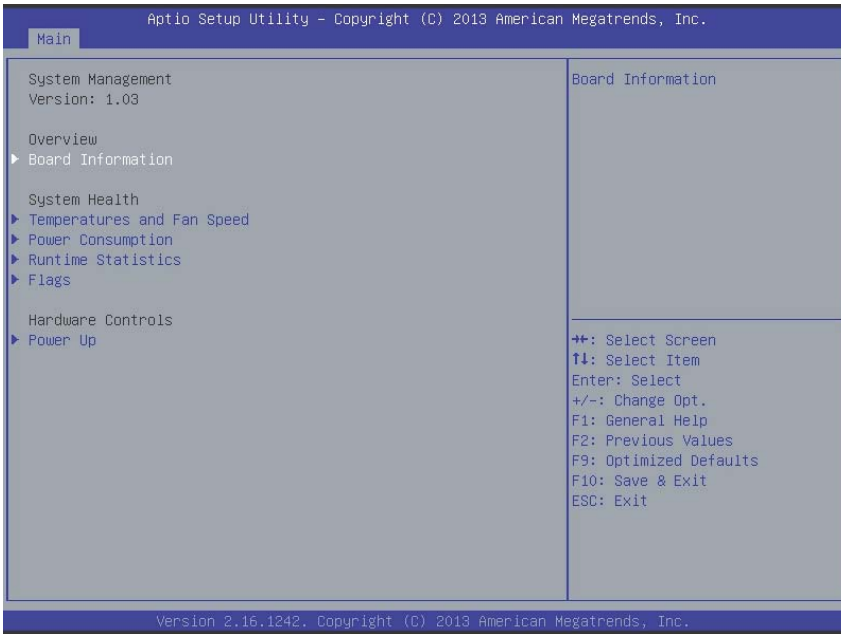

Board Information

Provides SEMA Board Information.

Temperatures and Fan Speed

Displays system temperatures and fan speed.

Power Consumption

Provides system power consumption information.

Runtime Statistics

Displays runtime statistics for the system.

Flags

Shows SEMA flags.

Power Up

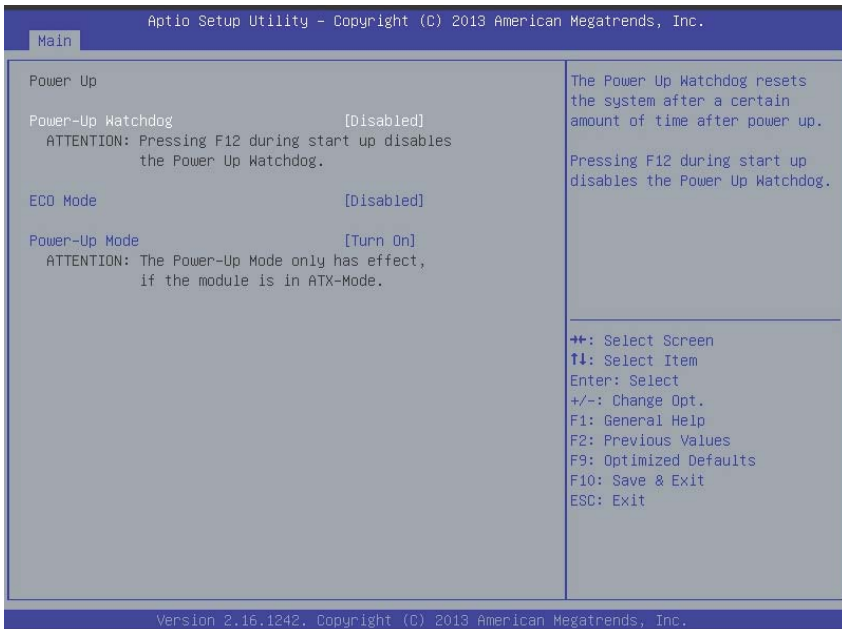

Power-Up Watchdog

Resets the system after a preset period after power up has passed.

ECO Mode

Reduces power consumption of the system. After shutdown, at least 5 seconds must pass before restart can be executed.

Power-Up Mode

Selecting Turn On starts the device automatically when the power supply is turned on.

Selecting Remain Off starts the device when the power button is pressed.

Selecting Last State powers up to the last power state

B.2 Advanced

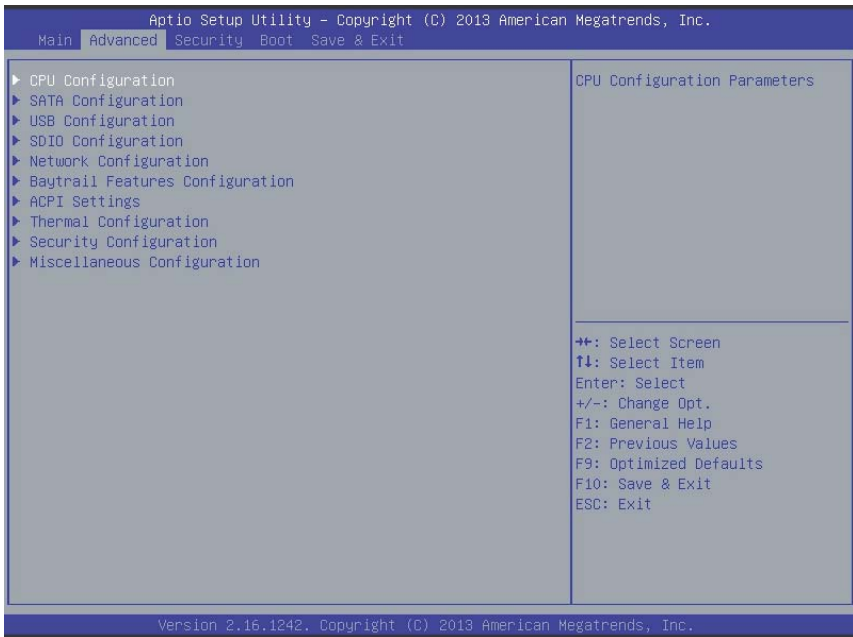

Setting incorrect or conflicting values in Advanced BIOS Setup may cause system malfunction.

B.2.1 CPU Configuration

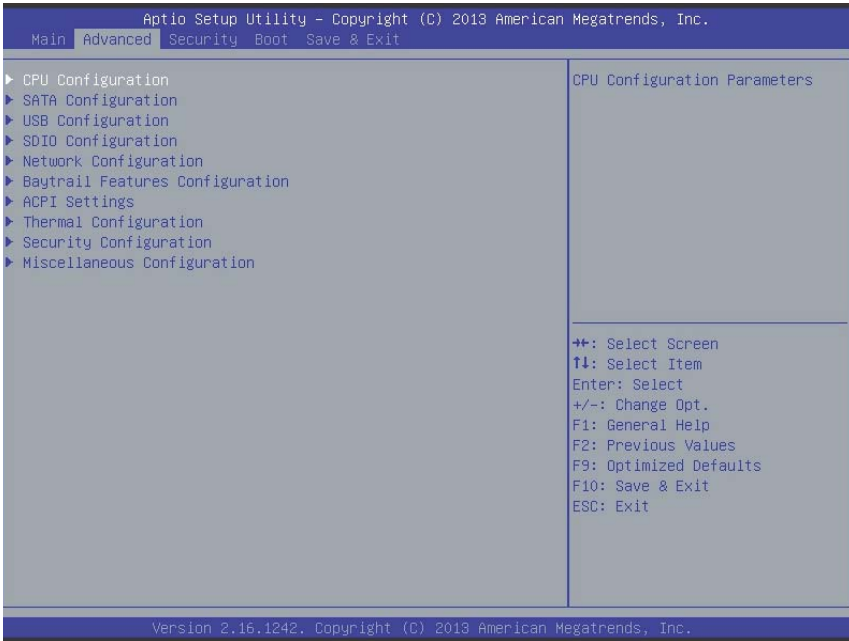

Limit CPUID Maximum

Disabled for Windows XP.

Execute Disable Bit

XD can prevent certain classes of malicious buffer overflow attacks when combined with a supporting OS (Windows Server 2003 SP1, Windows XP SP2, SuSE Linux 9.2, RedHat Enterprise 3 Update 3.)

Intel Virtualization Technology

When enabled, a VMM can utilize the additional hardware capabilities provided by Vanderpool Technology

Power Technology

Enables power management features.

Socket 0 CPU Information

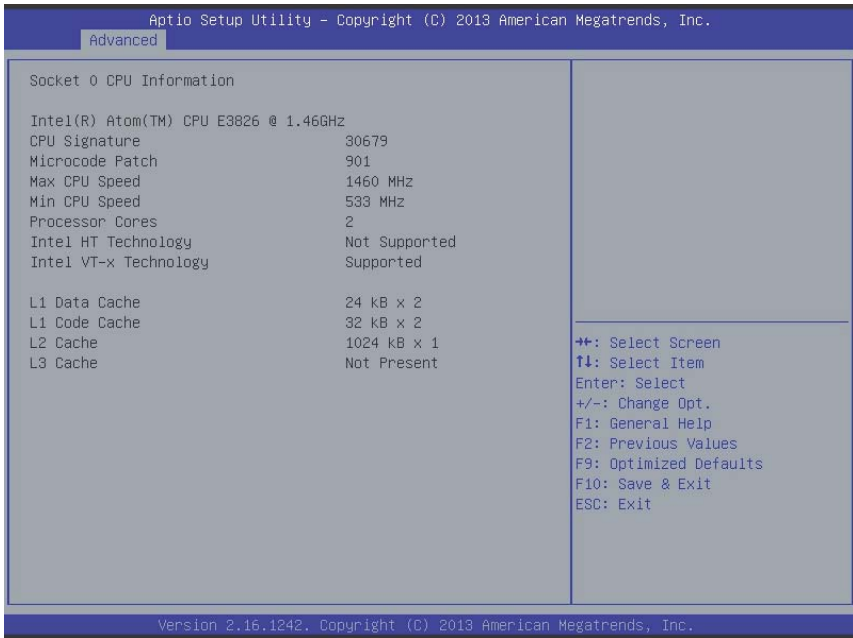

Feature	Description
CPU Brand Name	Displays CPU brand name
CPU Signature	Displays CPU signature
Microcode Patch	Displays microcode patch
Max CPU speed	Displays max CPU speed
Min CPU speed	Displays min CPU speed
Processor Cores	Displays processor cores
Intel HT Technology	Displays Intel HT Technology support status
Intel VT-x Technology	Displays Intel VT-x Technology support status
L1 Data Cache	Displays cache info

Feature	Description
L1 Code Cache	Displays cache info
L2 Cache	Displays cache info
L3 Cache	Displays cache info

CPU Thermal Configuration

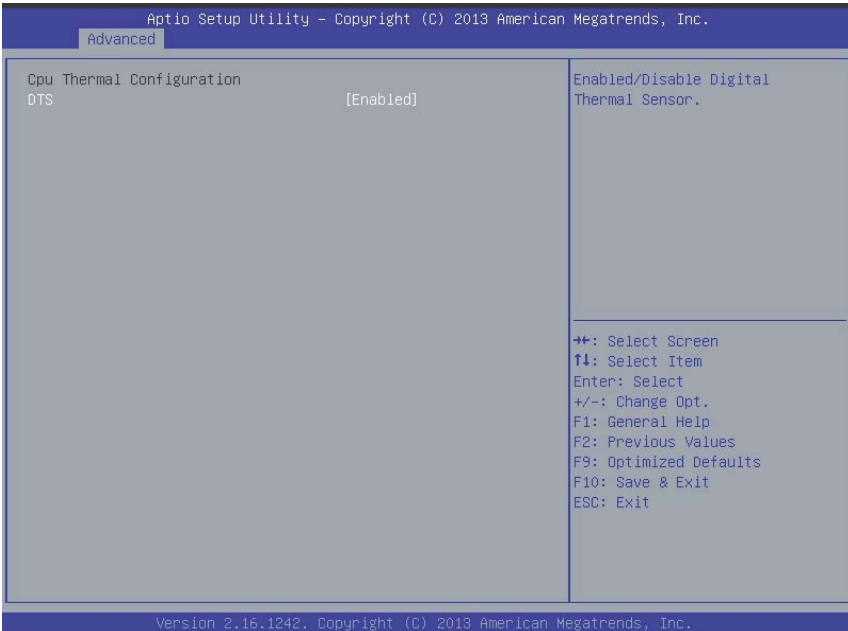

DTS

Enables/Disables Digital Thermal Sensor.

PPM Configuration

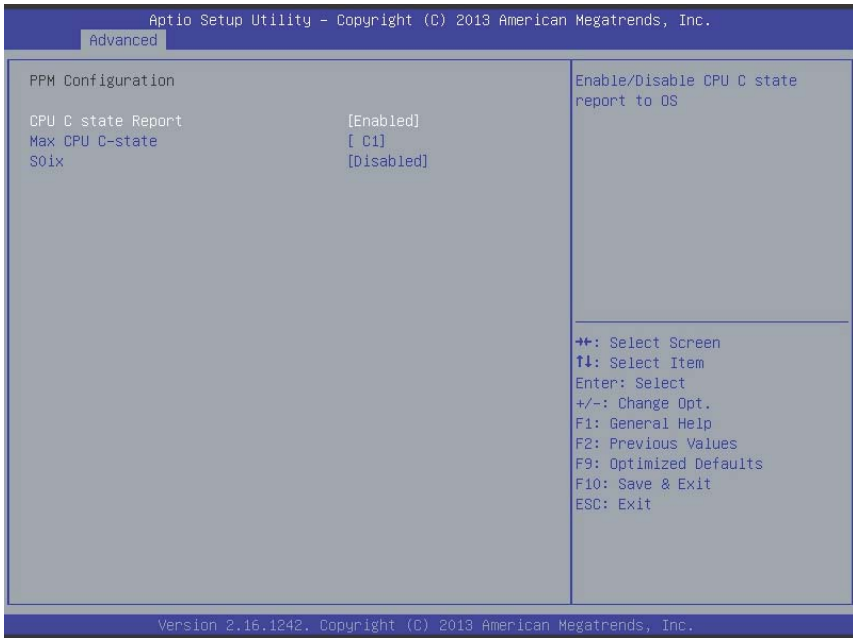

CPU C state Report

Enables/Disables reports of CPU C state to OS.

Max CPU C-state

Determines which Max C state the processor supports.

S0ix

Enables/Disables CPU S0ix state

B.2.2 SATA Configuration

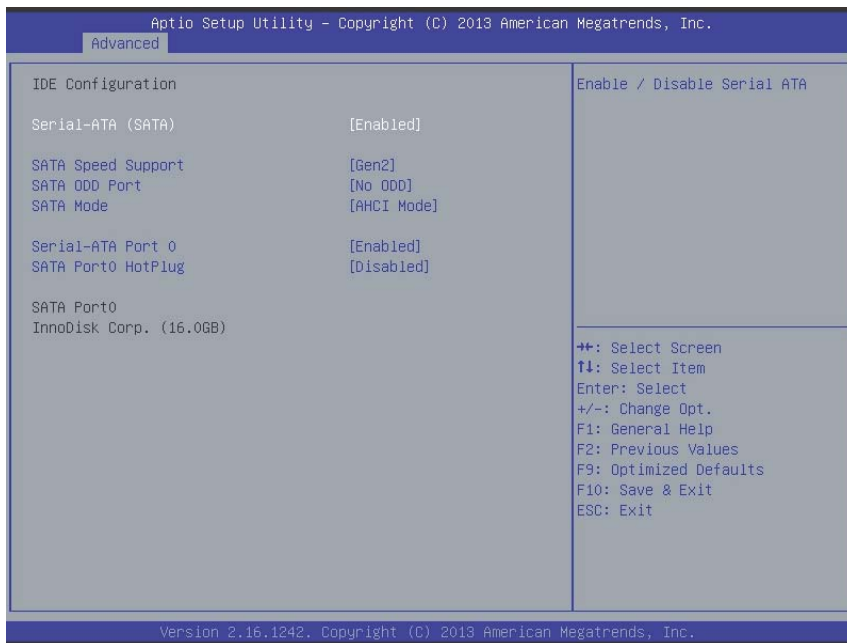

Serial-ATA (SATA)

Enables/Disables Serial ATA

SATA Speed Support

Selects SATA Speed Support Gen1 or Gen2

SATA Mode

Selects IDE/AHCI modes

Serial-ATA Port 0

Enables/Disables Serial ATA Port 0

SATA Port0 HotPlug

Enables/Disables Port O HotPlug capability

B.2.3 USB Configuration

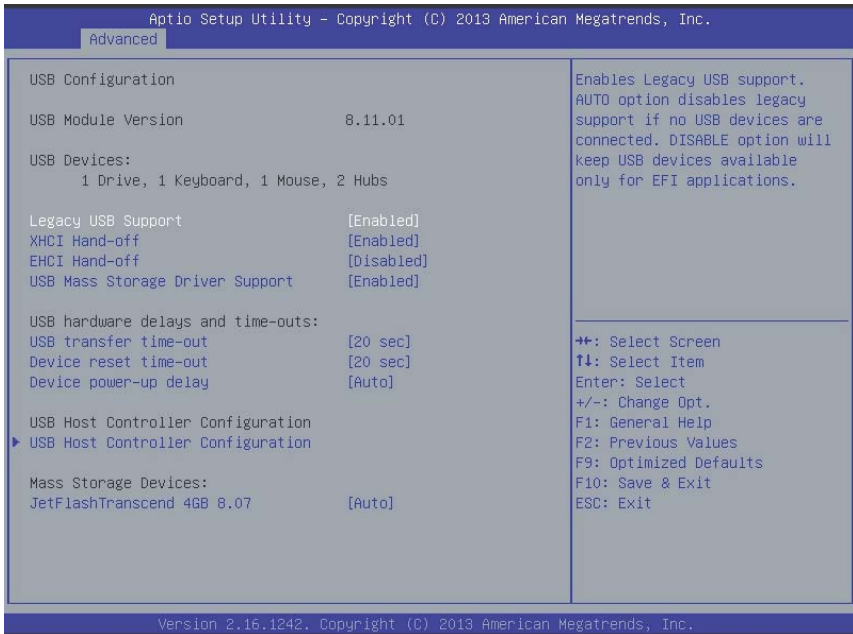

Legacy USB Support

Selecting AUTO disables legacy support if no USB devices are connected, and DISABLE keeps USB devices available for only EFI applications.

XHCI Hand-Off

A workaround for OSs without XHCI handoff support. XHCI ownership change should be claimed by XHCI driver.

EHCI Hand-Off

A workaround for OSs without EHCI handoff support. EHCI ownership change should be claimed by EHCI driver

USB Mass Storage Driver Support

Enables/disables USB Mass Storage Driver support.

USB transfer time-out

Timeout value for Control, Bulk, and Interrupt transfers.

Device reset time-out

USB mass storage device Start Unit command timeout.

Device power-up delay

Maximum time the device will take before reporting to the Host Controller. Selecting Auto employs the default value, ie for a Root port, 100 ms and for a Hub port the delay is taken from Hub descriptor.

USB Host Controller Configuration

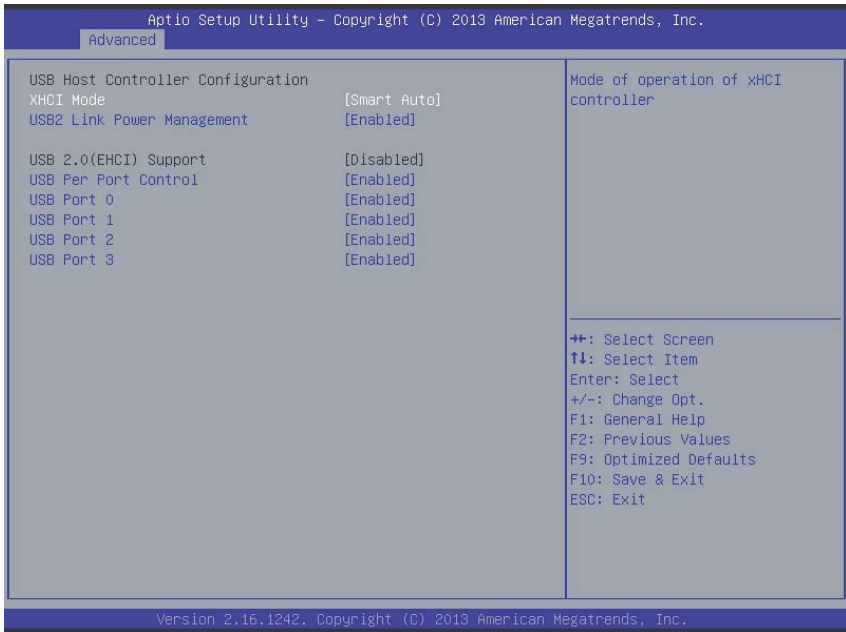

XHCI mode

Sets operating mode of XHCI controller.

USB2 Link Power Management

Enables/disables USB2 Link Power Management.

USB Per Port Control

Controls each USB port 0 to 3, Enabling USB per port, or Disabling by USB port x settings.

USB Port #0~3

Enables/disables USB Ports 0 to 3.

B.2.4 SDIO Configuration

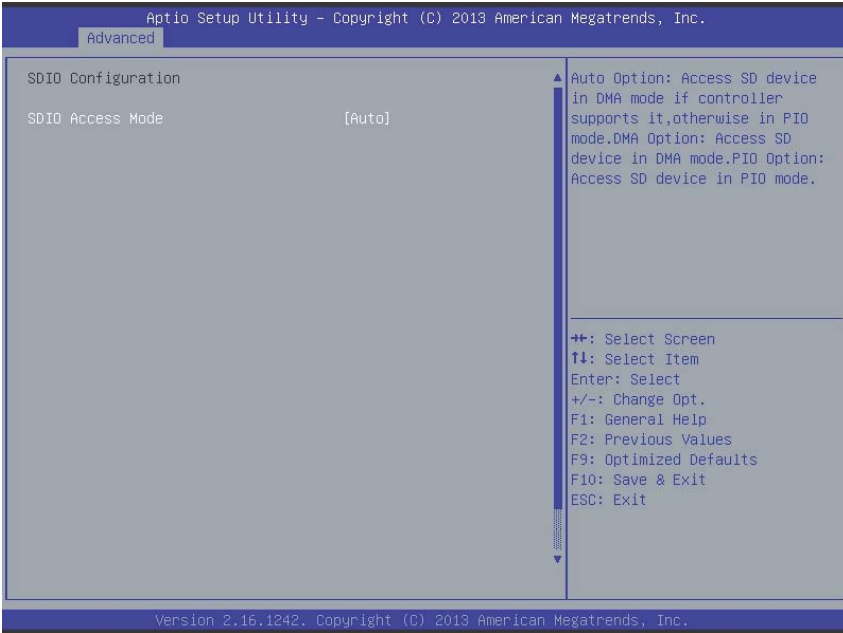

SDIO Access Mode

Selecting Auto accesses SD device in DMA mode if controller supported, otherwise in PIO mode. Selecting DMA accesses SD device in DMA mode, and selecting PIO Accesses SD device in PIO mode.

B.2.5 Network Configuration

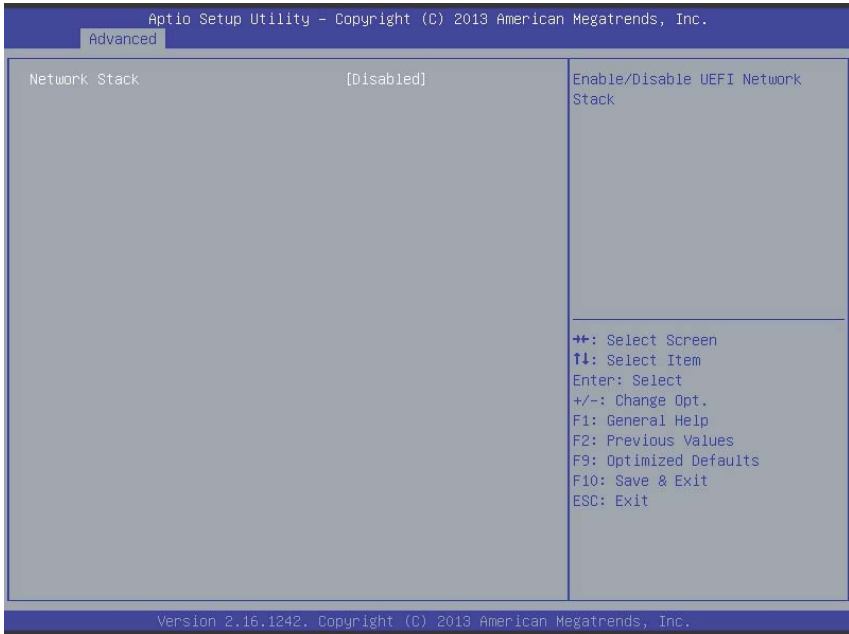

Network Stack

Enables/disables UEFI Network Stack

B.2.6 Baytrail Feature Configuration

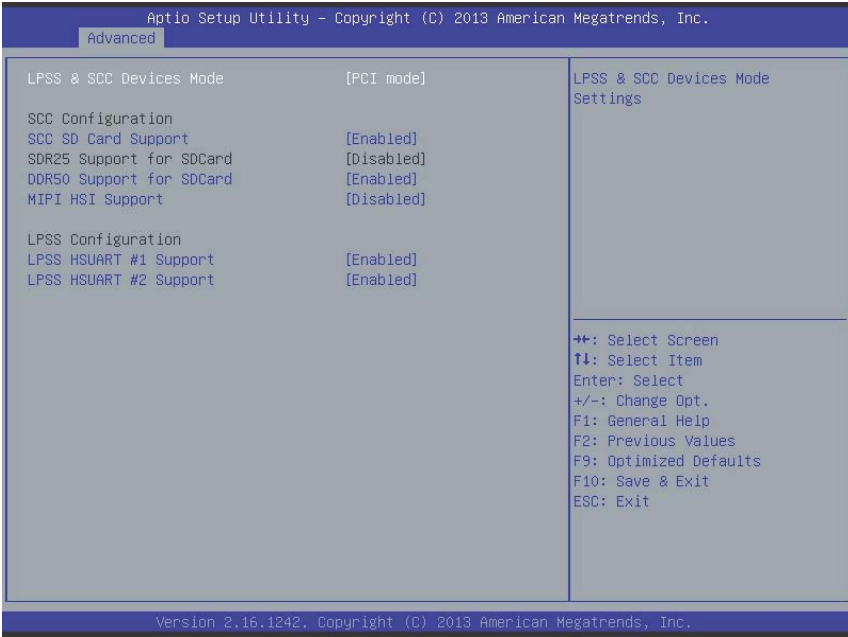

LPSS & SCC Devices Mode

Sets LPSS & SCC Device Mode.

SCC SD Card Support

Enables/Disables SCC SD Card support

DDR50 Support for SD Card

Enables/Disables DDR50 capability in SD card controller.

MIPI HSI Support

Enables/Disables MIPI HSI support.

LPSS HSUART # Support

Enables/Disables LPSS HSUART # support.

HSUART Port Mode

Sets HSUART port mode.

B.2.7 ACPI Setting

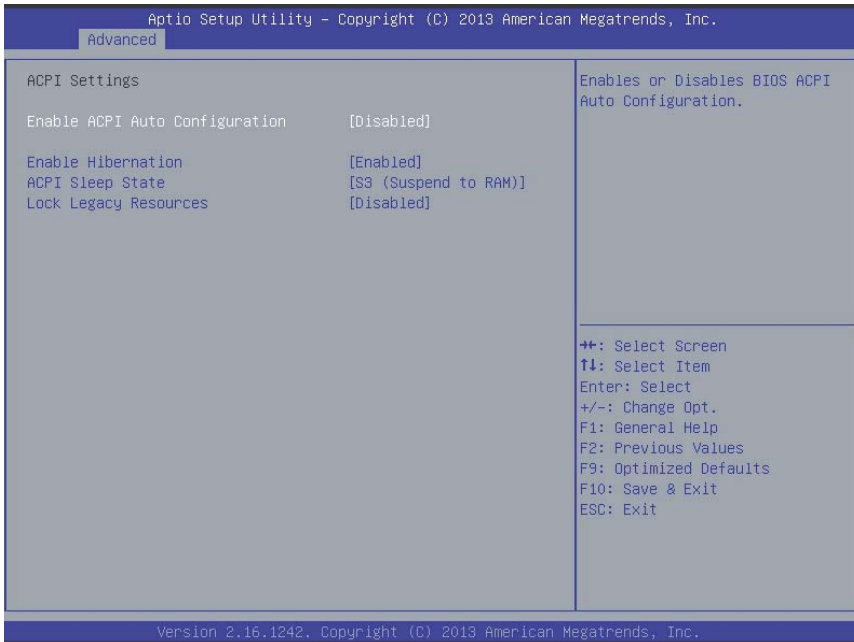

Enable ACPI Auto Configuration

Enables/Disables BIOS ACPI Auto Configuration.

Enable Hibernation

Enables/Disables hibernation capability (OS/S4 Sleep State), when supported by OS.

ACPI Sleep State

Selects the highest ACPI sleep state the system will enter when SUSPEND is selected.

Lock Legacy Resources

Enables/Disables Legacy Resource lock.

B.2.8 Thermal Configuration

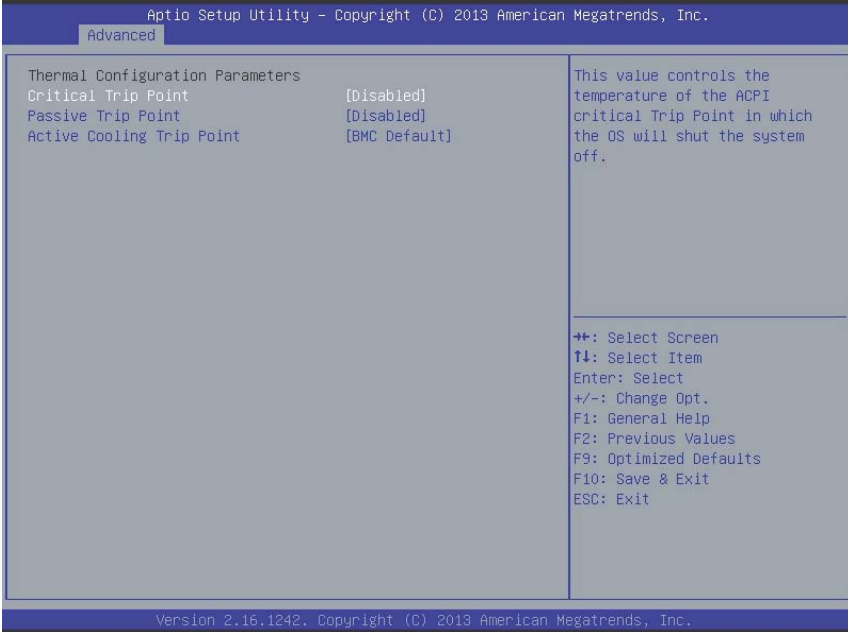

Critical Trip Point

Sets the ACPI critical trip point temperature at which the OS will shut the system down.

Passive Trip Point

Sets the temperature of the ACPI critical trip point at which the OS will begin throttling the processor

Active Cooling Trip Point

Sets the Active Cooling trip point.

B.2.9 Security Configuration

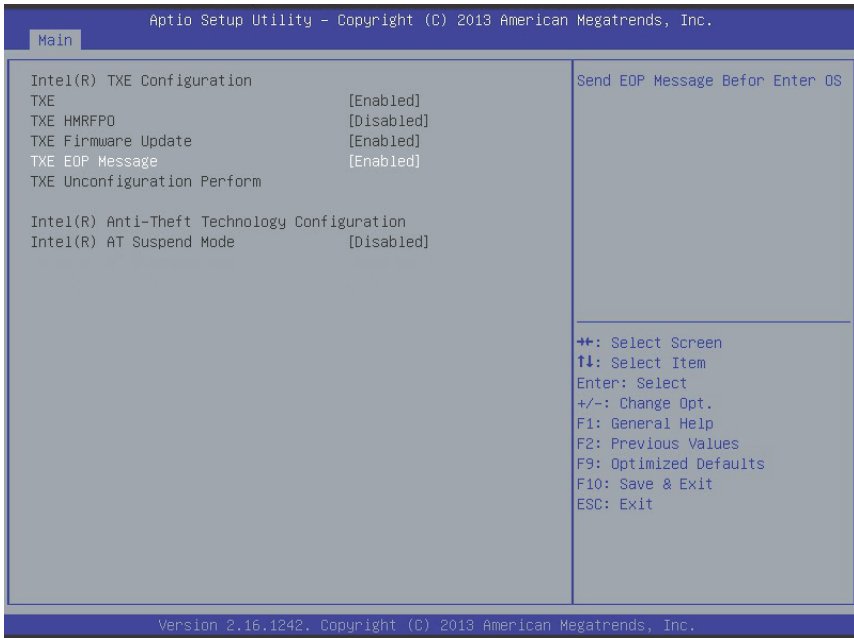

TXE

Enables/Disables TXE firmware

TXE HMRFB0

Enables/Disables TXE HMRFB0

TXE Firmware Update

Enables/Disables TXE firmware update.

TXE EOP Message

Sends EOP Message Before OS starts up.

TXE Unconfiguration Perform

Reverts TXE Settings to factory defaults.

B.2.10 Miscellaneous Configuration



OS Selection

Selects active OS.

B.3 Security

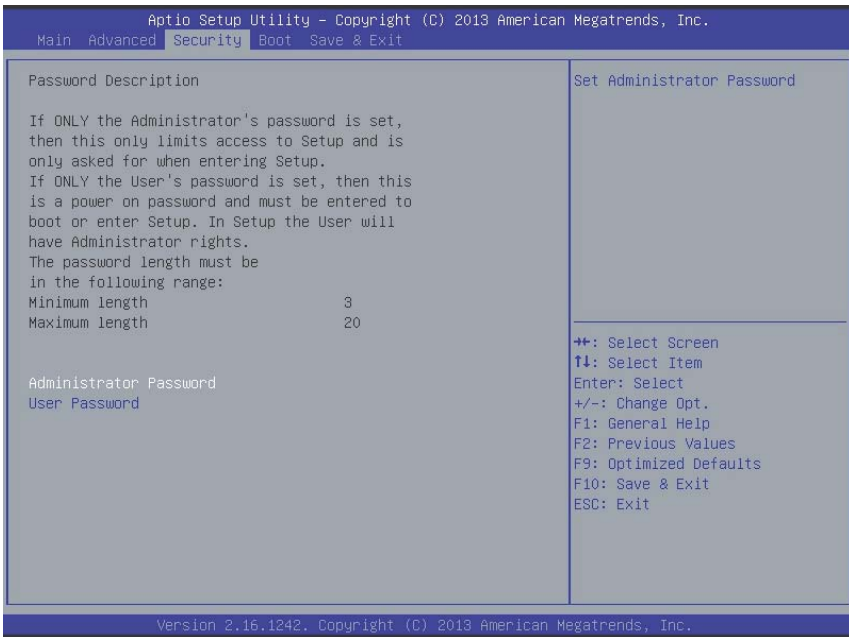

NOTE:

If only the Administrator's password is set, only access to Setup is limited and authorization requested only when entering Setup. If only the User's password is set, a password must be entered to boot or enter setup. In Setup the user has Administrator rights.

Administrator Password

Sets Administrator password.

User Password

Sets boot/setup User password.

B.4 Boot

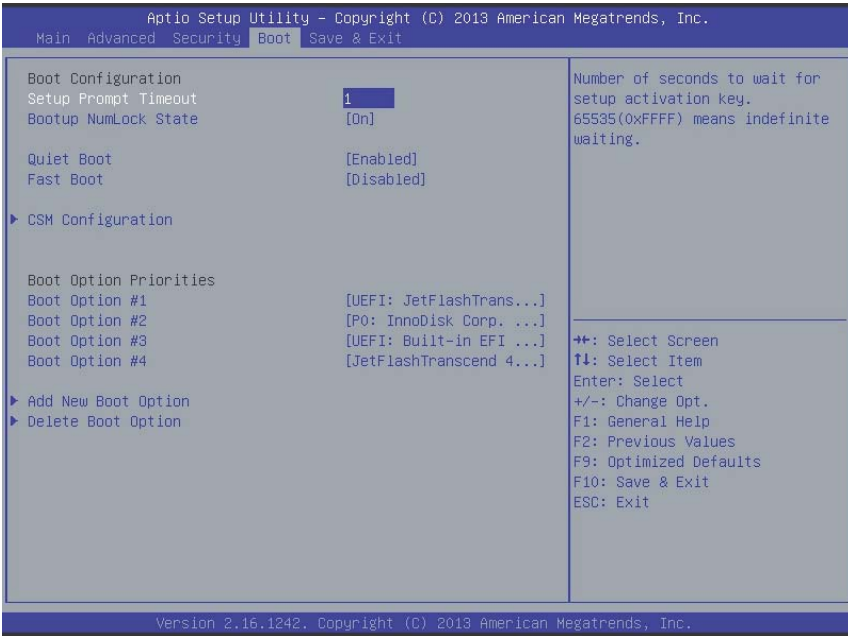

Setup Prompt Timeout

Sets number of seconds to wait for setup activation key.

Bootup Num-Lock State

Allows Number Lock setting to be modified during boot.

Quiet Boot

When Disabled, directs BIOS to display POST messages, when Enabled, directs BIOS to display the OEM logo.

Fast Boot

Enables or disables boot with initialization of the minimal set of devices required to launch active boot option. Has no effect on BBS boot options.

Boot Option Priorities

Specifies the priority of boot devices, with all installed boot devices detected during POST and displayed, where selecting Boot Option # specifies the desired boot device.

CSM Configuration

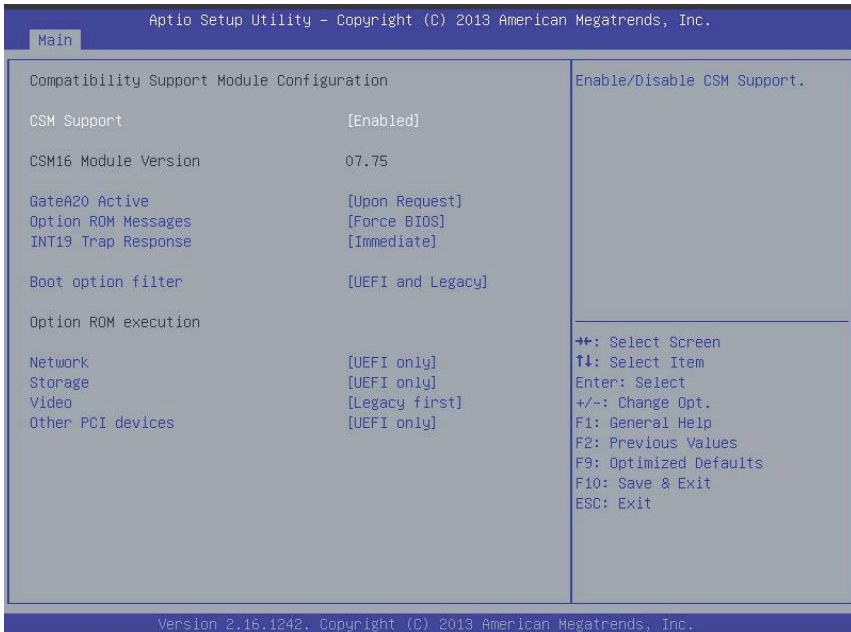

CSM Support

Enables/disables CSM support.

GateA20 Active

Selecting Upon Request allows GA20 to be disabled using BIOS services, and selecting Always disallows disabling of GA20, useful when any RT code exceeding 1MB is executed.

Option ROM Messages

Sets display mode for Options.

INT19 Trap Response

Sets BIOS reaction to INT19 trapping by Option ROM, where selecting Immediate executes the trap immediately, and Postponed executes the trap during a legacy boot.

Boot option filter

Sets Legacy/UEFI ROM priority.

Network

Sets execution of UEFI and Legacy PXE OpROM.

Storage

Sets execution of UEFI and Legacy Storage OpROM.

Video

Sets execution of UEFI and Legacy Video OpROM.

Other PCI devices

Determines OpROM execution policy for devices other than Network, Storage, or Video.

B.5 Exit

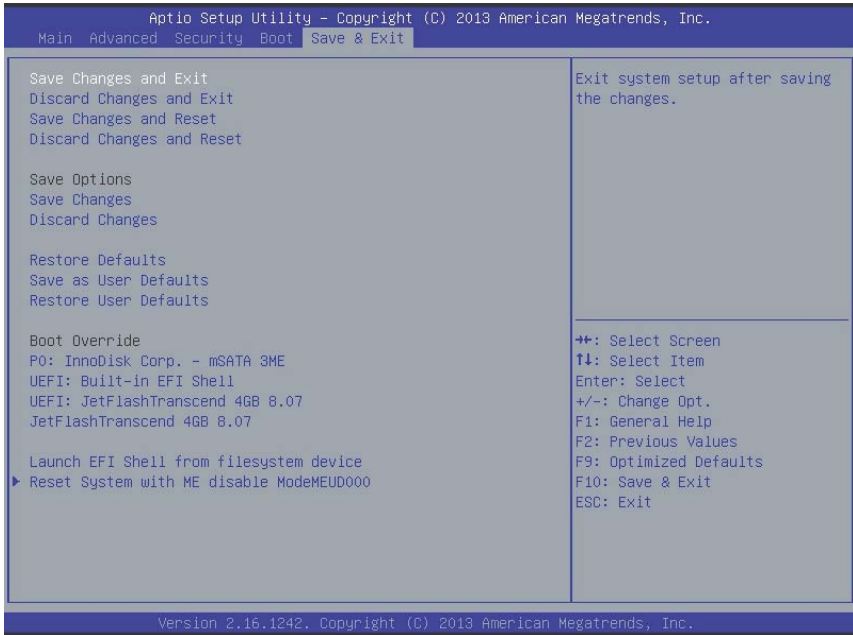

Save Changes and Exit

Exits Setup after saving changes.

Discard Changes and Exit

Exits Setup without saving any changes.

Save Changes and Reset

Resets the system after saving changes.

Discard Changes and Reset

Resets system setup without saving any changes.

Save Changes

Saves all changes made to Setup options.

Discard Changes

Discards changes made to Setup options.

Restore Defaults

Returns all BIOS options to Default settings, providing maximum system stability with limited performance. Applicable in the event of system configuration problems.

Save as User Defaults

Save changes as User Defaults.

Restore User Defaults

Restores User Defaults to all Setup options.

Launch EFI Shell from filesystem device

Initiates launch of EFI Shell application (Shellx64.efi) from an available filesystem device.

Reset System with ME disable ModeMEUD000

ME runs in temporary disable mode, not applicable if ME Ignition FWMEUD001.

Important Safety Instructions

For user safety, please read and follow all **instructions**, **WARNINGS**, **CAUTIONS**, and **NOTES** marked in this manual and on the associated equipment before handling/operating the equipment.

- ▶ Read these safety instructions carefully.
- ▶ Keep this user's manual for future reference.
- ▶ Read the specifications section of this manual for detailed information on the operating environment of this equipment.
- ▶ When installing/mounting or uninstalling/removing equipment:
 - ▷ Turn off power and unplug any power cords/cables.
- ▶ To avoid electrical shock and/or damage to equipment:
 - ▷ Keep equipment away from water or liquid sources;
 - ▷ Keep equipment away from high heat or high humidity;
 - ▷ Keep equipment properly ventilated (do not block or cover ventilation openings);
 - ▷ Make sure to use recommended voltage and power source settings;
 - ▷ Always install and operate equipment near an easily accessible electrical socket-outlet;
 - ▷ Secure the power cord (do not place any object on/over the power cord);
 - ▷ Only install/attach and operate equipment on stable surfaces and/or recommended mountings; and,
 - ▷ If the equipment will not be used for long periods of time, turn off and unplug the equipment from its power source.

- ▶ Never attempt to fix the equipment. Equipment should only be serviced by qualified personnel.
- ▶ A Lithium-type battery may be provided for uninterrupted, backup or emergency power.



Risk of explosion if battery is replaced with an incorrect type; please dispose of used batteries appropriately.

- ▶ Equipment must be serviced by authorized technicians when:
 - ▷ The power cord or plug is damaged;
 - ▷ Liquid has penetrated the equipment;
 - ▷ It has been exposed to high humidity/moisture;
 - ▷ It is not functioning or does not function according to the user's manual;
 - ▷ It has been dropped and/or damaged; and/or,
 - ▷ It has an obvious sign of breakage.

Please pay strict attention to all warnings and advisories appearing on the device, to avoid injury or damage.

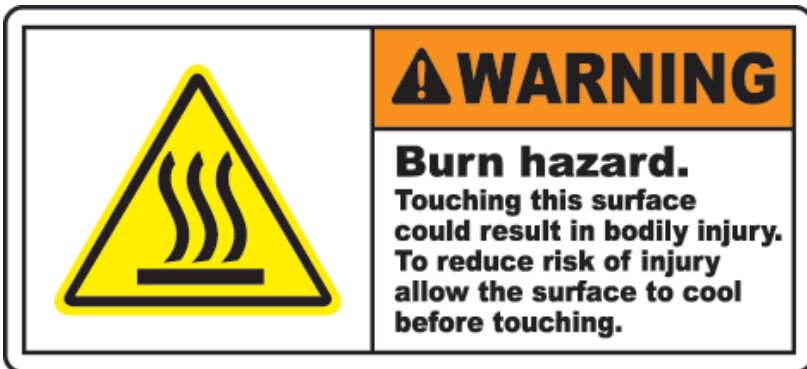

Getting Service

Contact us should you require any service or assistance.

ADLINK Technology, Inc.

Address: 9F, No.166 Jian Yi Road, Zhonghe District
New Taipei City 235, Taiwan
新北市中和區建一路 166 號 9 樓
Tel: +886-2-8226-5877
Fax: +886-2-8226-5717
Email: service@adlinktech.com

Ampro ADLINK Technology, Inc.

Address: 5215 Hellyer Avenue, #110
San Jose, CA 95138, USA
Tel: +1-408-360-0200
Toll Free: +1-800-966-5200 (USA only)
Fax: +1-408-360-0222
Email: info@adlinktech.com

ADLINK Technology (China) Co., Ltd.

Address: 上海市浦东新区张江高科技园区芳春路 300 号 (201203)
300 Fang Chun Rd., Zhangjiang Hi-Tech Park
Pudong New Area, Shanghai, 201203 China
Tel: +86-21-5132-8988
Fax: +86-21-5132-3588
Email: market@adlinktech.com

ADLINK Technology Beijing

Address: 北京市海淀区上地东路 1 号盈创动力大厦 E 座 801 室(100085)
Rm. 801, Power Creative E, No. 1 Shang Di East Rd.
Beijing, 100085 China
Tel: +86-10-5885-8666
Fax: +86-10-5885-8626
Email: market@adlinktech.com

ADLINK Technology Shenzhen

Address: 深圳市南山区科技园南区高新南七道 数字技术园
A1 栋 2 楼 C 区 (518057)
2F, C Block, Bldg. A1, Cyber-Tech Zone, Gao Xin Ave. Sec. 7
High-Tech Industrial Park S., Shenzhen, 518054 China
Tel: +86-755-2643-4858
Fax: +86-755-2664-6353
Email: market@adlinktech.com

LiPPERT ADLINK Technology GmbH

Address: Hans-Thoma-Strasse 11, D-68163
Mannheim, Germany
Tel: +49-621-43214-0
Fax: +49-621 43214-30
Email: emea@adlinktech.com

ADLINK Technology, Inc. (French Liaison Office)

Address: 6 allée de Londres, Immeuble Ceylan
91940 Les Ulis, France
Tel: +33 (0) 1 60 12 35 66
Fax: +33 (0) 1 60 12 35 66
Email: france@adlinktech.com

ADLINK Technology Japan Corporation

Address: 〒101-0045 東京都千代田区神田鍛冶町 3-7-4
神田 374 ビル 4F
KANADA374 Bldg. 4F, 3-7-4 Kanda Kajicho,
Chiyoda-ku, Tokyo 101-0045, Japan
Tel: +81-3-4455-3722
Fax: +81-3-5209-6013
Email: japan@adlinktech.com

ADLINK Technology, Inc. (Korean Liaison Office)

Address: 137-881 서울시 서초구 서초대로 326, 802 (서초동, 모인터빌딩)
802, Mointer B/D, 326 Seocho-daero, Seocho-Gu,
Seoul 137-881, Korea
Tel: +82-2-2057-0565
Fax: +82-2-2057-0563
Email: korea@adlinktech.com

ADLINK Technology Singapore Pte. Ltd.

Address: 84 Genting Lane #07-02A, Cityneon Design Centre
Singapore 349584
Tel: +65-6844-2261
Fax: +65-6844-2263
Email: singapore@adlinktech.com

ADLINK Technology Singapore Pte. Ltd. (Indian Liaison Office)

Address: #50-56, First Floor, Spearhead Towers
Margosa Main Road (between 16th/17th Cross)
Malleswaram, Bangalore - 560 055, India
Tel: +91-80-65605817, +91-80-42246107
Fax: +91-80-23464606
Email: india@adlinktech.com

ADLINK Technology, Inc. (Israeli Liaison Office)

Address: 27 Maskit St., Corex Building
PO Box 12777
Herzliya 4673300, Israel
Tel: +972-54-632-5251
Fax: +972-77-208-0230
Email: israel@adlinktech.com

ADLINK Technology, Inc. (UK Liaison Office)

Tel: +44 774 010 59 65
Email: UK@adlinktech.com