

IDS-3218W

18.5" HD Panel Mount Monitor

NEW



Features

- 18.5" HD LCD panel with LED backlight for 20% power saving and environmental protection
- 0° ~ 55° C wide range operating temperature
- 5-wire resistive and P-cap touchscreen solution
- Touch interface: USB & RS-232
- Multiple signal interface with VGA, DVI & HDMI
- Integrated bracket for easy installation
- Versatile mounting methods for rear mounting and VESA mounting
- Anti-Reflective treatment (optional)
- Optical bonding (optional)

Introduction

The Advantech IDS-3218W Panel Mount series offers flexible options for touchscreens, signal interfaces and chassis mounting. The series also supports rear and VESA mounting. The integrated brackets bring the benefits of easy installation and provide flexibility for different applications.

Specifications

	Model	IDS-3218WG	IDS-3218WR	IDS-3218WP
Display	Size	18.5" LED panel	18.5" LED panel	18.5" LED panel
	Resolution	1366 x 768 (HD)	1366 x 768 (HD)	1366 x 768 (HD)
	Viewing Angle	85°/85°/ (H), 80°/ 80° (V)	85°/85°/ (H), 80°/ 80° (V)	85°/85°/ (H), 80°/ 80° (V)
	Brightness	300 (cd/m ²)	300 (cd/m ²)	300 (cd/m ²)
	Color Support	16.7M	16.7M	16.7M
	Contrast Ratio	1000:1	1000:1	1000:1
	Response Time	5 [msec]	5 [msec]	5 [msec]
	Backlight Life (hrs)	50,000 hrs	50,000 hrs	50,000 hrs
Touchscreen	Touchscreen Type	N/A	5-Wire Resistive Touchscreen	Projected Capacitive Touchscreen
	Surface Hardness	8H	3H	6H
	Durability	N/A	10 million touches	50 million touches
	Transparency	90%	80% ± 3%	96% (min.)
Environment	Operating Temperature	0 ~ 55 °C	0 ~ 55 °C	0 ~ 55 °C
	Storage Temperature	-20 ~ 60 °C	-20 ~ 60 °C	-20 ~ 60 °C
	Humidity	90% @ 40 °C, non-condensing	90% @ 40 °C, non-condensing	90% @ 40 °C, non-condensing
	Package Vibration	5-500 Hz, 0.026G ² /Hz, 2.16Grms, X, Y, Z, 1 hour per axis		
System	I/O	VGA x1; DVI-D x1; HDMIx1; 12 V _{DC} Jack x1	VGA x1; DVI-D x1; HDMIx1; 12 V _{DC} Jack x1; USB x1; RS-232 x1 (USB & RS-232 are reserved for the connection to enable touch usage only)	VGA x1; DVI-D x1; HDMIx1; 12 V _{DC} Jack x1; USB x1 (USB is reserved for the connection to enable touch usage only)
	OSD	Keys: Menu, Up, Down, Auto Adjust, Monitor Power on/off Menu Functions: Color, Image Setting, OSD Menu, Signal Source, Reset		
	Power	12V _{DC} , 5A (Optional), Only Limited Power Source (LPS) type of power supply is used		
	EMC Compliance	CE/FCC/CCC		
	Net Weight	5 Kg		
	Gross Weight	7 Kg		

Dimensions

Unit: mm

IDS-3218WG/IDS-3218WR

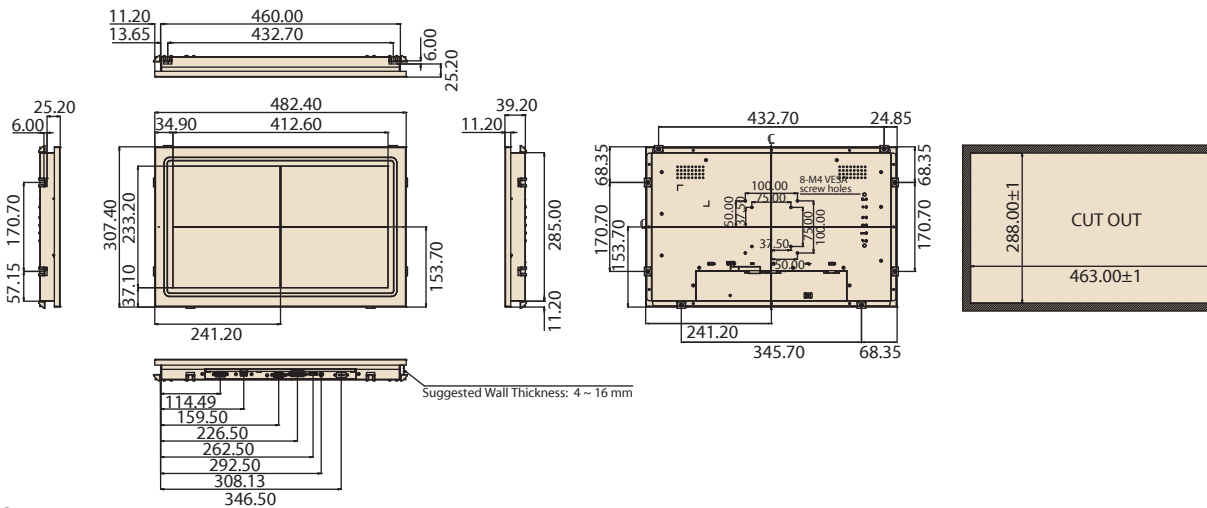

IDS-3218WP

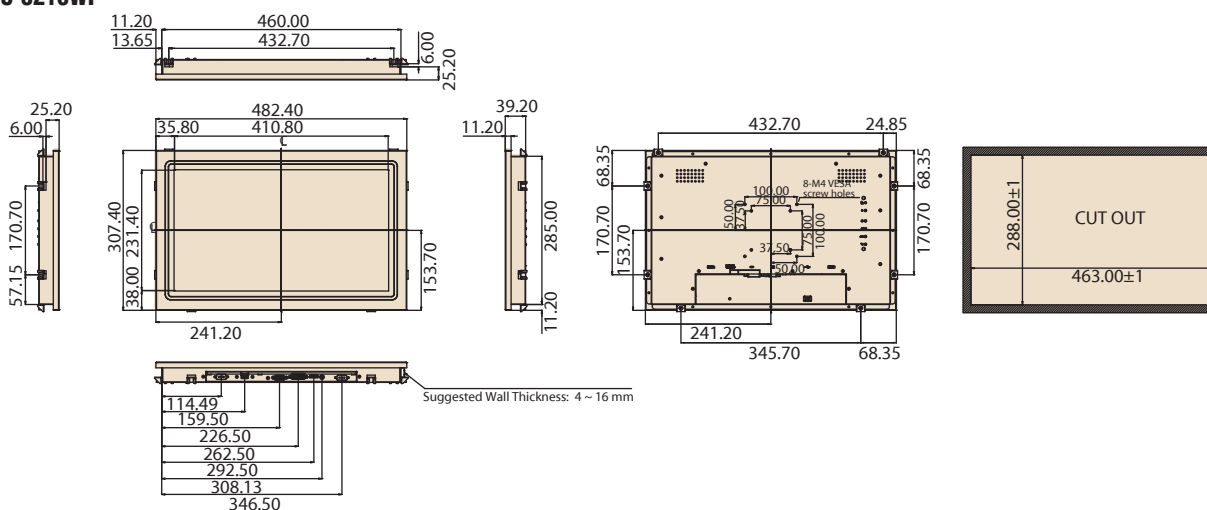

Packing List

Part Number	Description
1700002215	1 x M Cable USB-A(M)/USB-A(M) 180CM
1700021332-01	1 x VGA cable 15P(M) 1.8 meter
1962055040	8 x Clamper
1935042520	8 x Screw of clamper M4_25L
1992610005	1 x Cable clamp
1933030500	1 x Screw of cable clamp
1992602010	1 x cable tie

*USB cable is only included in the touch series.

Note: Package contents are subject to change without prior notice

Optional Items

PartNumber	Description
1702002600	3-Pin power cord (USA)
1700000596	3-Pin power cord (China)
1700018705	3-Pin power cord (EU)
1700000243	DVI cable 2.0 meter
96PSA-A60W12R1-3	ADAPTER AC 100-240V 60W +12V/5A

Ordering Information

ModelName	Description
IDS-3218WG-30HDA1	18.5" HD 300cd/m ² Panel Mount Monitor
IDS-3218WR-30HDA1	18.5" HD 300cd/m ² Resistive touch Panel Mount Monitor
IDS-3218WP-30HDA1	18.5" HD 300cd/m ² P-cap touch Panel Mount Monitor